



# Audio Engineering Society Convention Paper

Presented at the 118th Convention  
2005 May 28–31 Barcelona, Spain

*This convention paper has been reproduced from the author's advance manuscript, without editing, corrections, or consideration by the Review Board. The AES takes no responsibility for the contents. Additional papers may be obtained by sending request and remittance to Audio Engineering Society, 60 East 42<sup>nd</sup> Street, New York, New York 10165-2520, USA; also see [www.aes.org](http://www.aes.org). All rights reserved. Reproduction of this paper, or any portion thereof, is not permitted without direct permission from the Journal of the Audio Engineering Society.*

## Simple Self-Oscillating Class D Amplifier with Full Output Filter Control

Bruno Putzeys<sup>1</sup>

<sup>1</sup> Philips Applied Technologies, BE3001 Leuven, Belgium  
[bruno.putzeys@philips.com](mailto:bruno.putzeys@philips.com)  
([bruno.putzeys@gmail.com](mailto:bruno.putzeys@gmail.com))

### ABSTRACT

A stable and load-invariant self-oscillation condition is developed for a class D amplifier employing only one single voltage feedback loop taking off after the output filter. The resulting control method is shown to effectively remove the output filter from the closed loop response. Practical discrete implementations of a comparator and gate-drive circuit are presented. A high-performance class D amplifier employing only 14 discrete transistors is constructed. Higher-order extensions of the control circuit are demonstrated which produce extremely low levels of distortion.

### 1. INTRODUCTION

A class D amplifier operates by deriving a discrete-state signal (usually two-state) from a continuous control signal and amplifying this using power switches. At the core of every class D amplifier is at least one comparator and one switching power stage. In all but the lowest power amplifiers, a passive LC filter is added.

#### 1.1. Hysteresis switching

From quite early on, designers have realised that a working amplifier can be built using only this and a handful of passives. The most well known method is hysteresis switching.

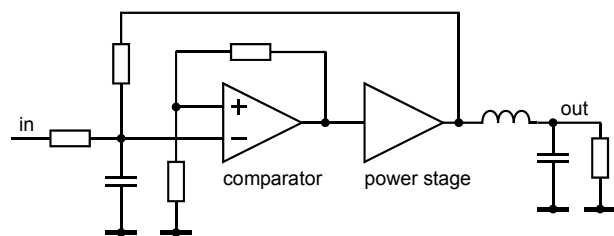

The obvious shortcoming of this circuit is the variability of the switching frequency in function of the power supply voltage. A minor modification is to use the switching waveform itself as the hysteresis feedback.

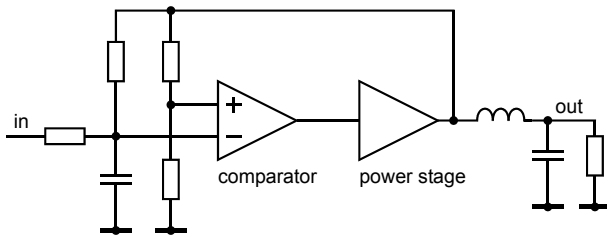

Amplifiers constructed along these lines typically produce fairly respectable performance, accounting for the popularity of this arrangement.

This still leaves two rather serious drawbacks. The most important problem is the lack of control over the output filter. The other is that the minimum pulse width produced is only half that of the idle pulse width. The operating frequency swings quite strongly with modulation index, following a parabola with its maximum at zero modulation and hitting zero at maximum modulation. The result is a very recognizable “tizz” close to clipping, as the switching frequency traverses the audio band. The oscillogram of the output (second order reconstruction filter presumed) is very recognizable.

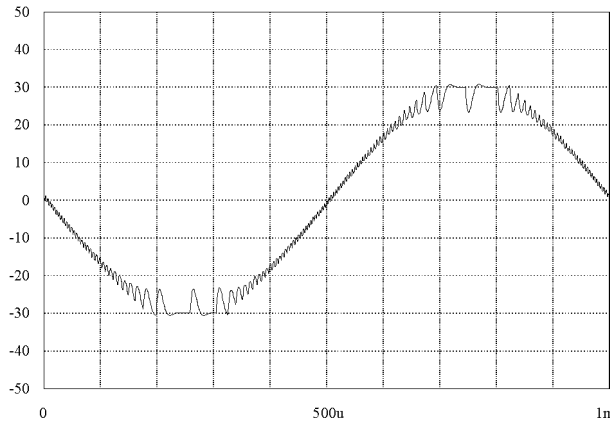

Some control is to be had over the output filter by adding PD control around it.

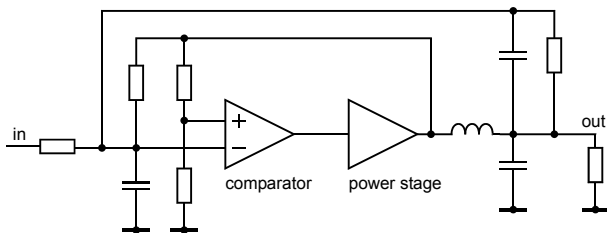

Although this reduces filter-induced distortion, improves loop gain and reduces the frequency response

error with varying loads to a few dB at most, the frequency modulation problem is exacerbated, resulting in instability when no load is attached.

This is not to say that hysteresis modulators are forever doomed for mediocrity. One very effective control scheme uses the current through the reconstruction filter’s capacitor current as the feedback variable in a hysteresis modulator, producing very low output impedance. The method addresses the large frequency modulation by controlling the hysteresis step size [1]. All in all, the complexity of both the current sensing and the hysteresis modulation leave room for an alternative method.

**1.2. Phase-shift controlled oscillation**

A method of obtaining self-oscillation without the use of hysteresis employs the phase shift of the feedback network to produce stable self-oscillation. The amplifier will oscillate at the frequency where the feedback network has a 180-degree phase shift.

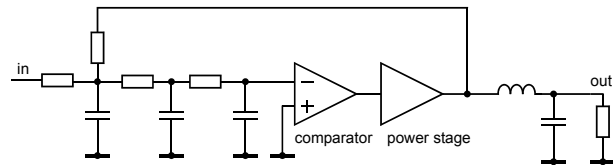

A rather pleasing characteristic of this method is that the switching frequency can be made much more stable than with a hysteresis modulator. In theory the minimum pulse width at maximum modulation becomes zero (in practice about twice the propagation delay of the active electronics). Switching frequency still drops to zero in the process, but only much later and much less energy will be in the carrier by that time. After reconstruction by a second order filter the amplitude of the residual remains nearly constant. Even under careful listening conditions, the clipping behaviour sounds indistinguishable from that of a good linear amplifier.

A notable disadvantage of phase control is that the modulation is inherently nonlinear, adding distortion at large modulation indexes.

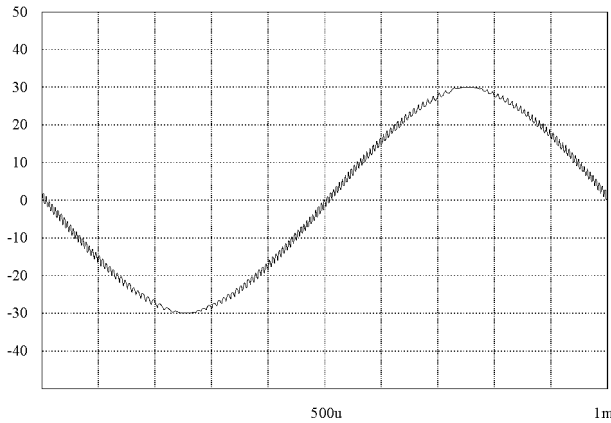

Phase-shift controlled amplifiers are in turn sometimes equipped with additional loop encompassing the reconstruction filters, again in order to make the frequency response less dependent on load<sup>[2]</sup>. An undesirable side effect is that usually the frequency modulation near clipping is increased again, producing oscilloscope pictures very similar to the hysteresis modulator.

## 2. PHASE-SHIFT CONTROL USING THE RECONSTRUCTION FILTER

### 2.1. Oscillation Condition

The phase shift of the reconstruction filter is usually seen as a burden, rarely as an advantage. Second order filters turn out to be very interesting for building phase-shift controlled amplifiers with. One is reminded that the switching frequency is set well beyond the corner frequency of the filter. At any sufficiently high frequency a second order low pass filter produces a phase shift close to 180 degrees. Varying load conditions only affect this to the order of a few degrees.

Closing a negative feedback loop around such a filter is not enough though. Oscillation occurs at a phase shift of exactly 180 degrees (the other 180 degrees are furnished by the polarity inversion), which only happens at infinity. An additional network is in order that holds the phase shift well away from 180 degrees below the desired switching frequency, and another one that pushes it well beyond it above this frequency.

Any practical circuit will already have the latter for free. The combined propagation delays of the comparator and the power stage constitute a phase shift directly proportional to frequency. The former can be as simple as a phase lead network in the feedback path.

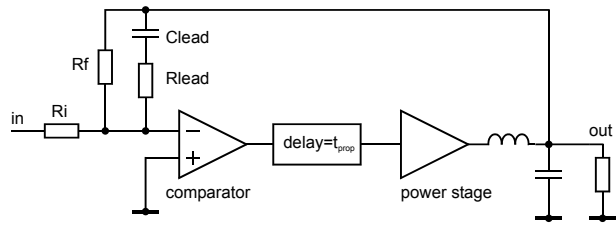

Since at any useful oscillation frequency the phase shift of the output filter is for all intents and purposes 180 degrees, oscillation will occur at the frequency where the propagation delay and the phase lead cancel out. Care should be taken to insure that under any realistic load condition there is not a second point with 180 degrees phase shift, because this point will be most certainly be the physical resonance frequency filter. Failing this usually leads to the undoing of the amplifier the first time it is overdriven with no load attached.

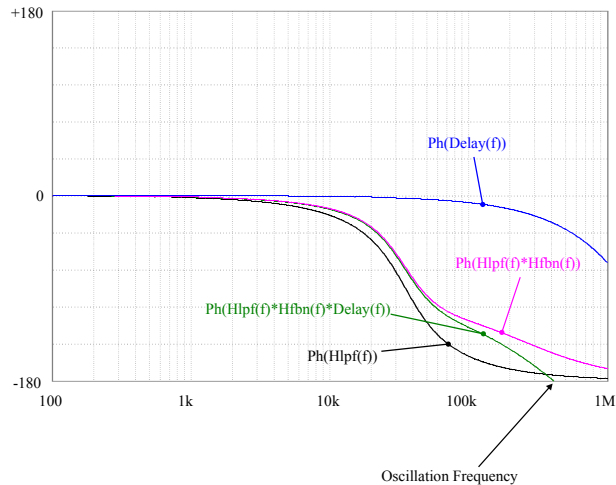

Where  $H_{lpf}$  is the transfer function of the LC filter and  $H_{fbn}$  that of the feedback network. Delay(s) is a linear phase shift function representing the propagation delay.

### 2.2. Loop Gain

So far we have seen that a functional and stable oscillator can be built by closing the loop around a class D power stage and its output filter with the aid of no more than a phase lead network. But is it an amplifier? The answer to that question will depend on the loop gain and the resulting audio performance.

### 2.2.1. Linearised DC gain of the comparator and the power stage

(Note: in the following analysis, amplitude is always meant to be peak amplitude)

In class D amplifiers employing a triangle wave or saw tooth oscillator to compare the control signal to, DC gain of the combined comparator and power stage is the amplitude of the square wave before the output filter (equals the supply voltage) divided by the amplitude of the triangle wave:

$$A_{DC} = \frac{V_{sq}}{V_{tri}} \quad (1)$$

In the present circuit, the reference waveform is the signal found at the comparator inputs as a result of the self-oscillation. Of the square wave produced by the power stage, little more than an attenuated fundamental is left.

When the reference waveform is not a triangle or sawtooth, the modulation becomes nonlinear. For small signal use, the gain is approximated based on the slope of the waveform. For a sinusoidal reference waveform of amplitude  $V_c$ , small-signal gain is identical to that found with a triangle wave that has the same slope at the zero crossings (i.e. is tangential). This is a triangle wave with an amplitude  $\pi/2$  that of the sine wave.

$$A_{DC} = \frac{V_{sq}}{\frac{\pi}{2} \cdot V_c} \quad (2)$$

The fundamental of a square wave with amplitude  $V_{sq}$  has an amplitude of:

$$V_{fund} = \frac{4}{\pi} \cdot V_{sq} \quad (3)$$

The amplitude at the comparator input becomes

$$V_c = \frac{4}{\pi} \cdot V_{sq} \cdot |H_{lpf}(s_{sw}) \cdot H_{fbn}(s_{sw})| \quad (4)$$

Following from (4) and (2), DC gain becomes

$$A_{DC} = \frac{V_{sq}}{2 \cdot V_{sq} \cdot |G(s_{sw}) \cdot H(s_{sw})|}$$

A result worth remembering. The linearised DC gain of the comparator and the power stage in a self-oscillating system with 180-degree oscillation condition equals one half divided by the gain of the feedback network (which here includes the output filter). If the feedback network has 40dB of loss, the linearised gain is 34dB.

Finally, loop gain is

$$H_{loop}(s) = A_{DC} \cdot H_{lpf}(s) \cdot H_{fbn}(s) \cdot \text{Delay}(s)$$

### 2.2.2. Small-signal model

The small-signal behaviour of the new circuit can now be analysed by substituting a linear gain block of gain  $A_{DC}$  for the comparator and the power stage.

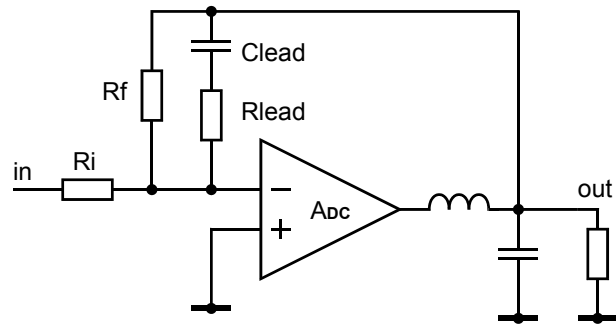

To continue symbolic analysis from here would detract from the kind of clarity some graphs have to offer. Having reduced the switching portion of the circuit to a gain block, we may analyse the circuit in a suitable circuit analysis program.

A plot of loop gain and closed loop gain of the amplifier shows the effectiveness of the new control method. In the example circuit,  $R_i=1.8k$ ,  $R_f=8.2k$ ,  $R_{lead}=1k$ ,  $C_{lead}=270pF$  and the active circuitry has a propagation delay of 210ns.

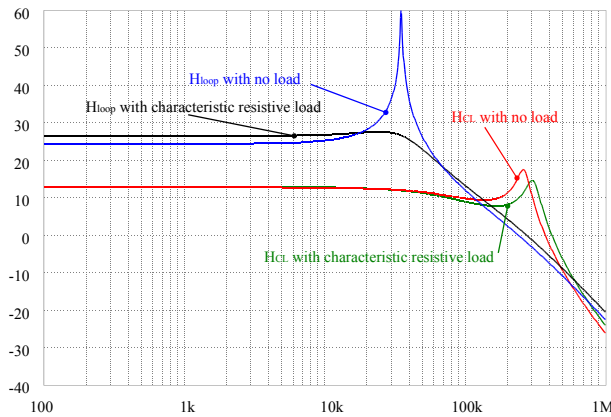

The closed loop gain is remarkably indifferent to the attached load. The physical resonance of the output filter does not show at all in the closed loop response. Fully enclosing the output filter in a single control loop ensures that any gain boost produced by it is subsequently countered by an equal boost of the loop gain. The high-frequency peak coincides with the switching frequency and therefore not meaningful.

**2.3. Higher order circuits**

The loop gain produced by the sample circuit is a rather modest 25dB. Although it is a second order circuit, no gain is available below the corner frequency of the output filter. The loop gain can be improved by adding extra integrator. While extending the output filter to a higher order would be feasible, it is rather more economic to place the extra poles in the feedback network.

Extra poles can be made passive or active. Active poles can be placed near DC (or even made complex) to produce better loop gains at low frequencies.

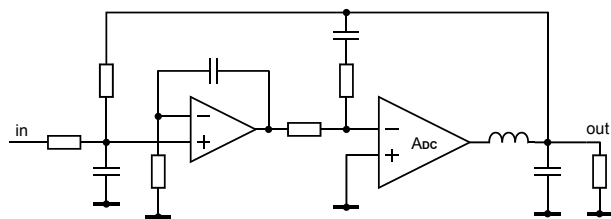

Passive poles are real and at fairly high frequencies. It is the author's experience that the latter are acoustically preferable, even though the former produce more spectacular paper specifications.

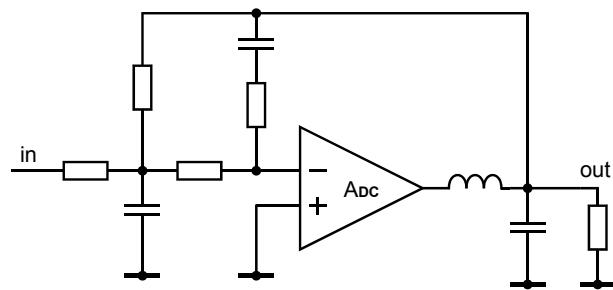

The similarity with multiple-feedback filter circuits is more than passing. The in-band response of a class D amplifier with this control circuit exactly matches that of a second order MFB section built with the same component values. A step response plot of the class D amplifier overlaid with that of the corresponding low pass filter exemplifies this. The difference between the two, shown in the bottom trace is only the switching residual.

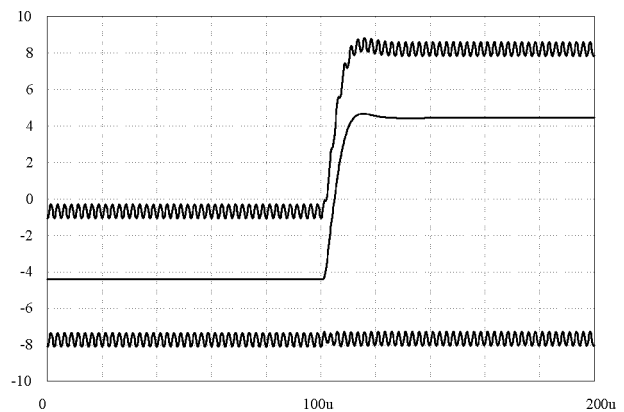

Note again that this is completely independent of the attached load.

**3. DISCRETE CIRCUIT IMPLEMENTATION**

The original aim of this development was to build a low-cost circuit. Half-bridge operation on split supplies was found to be the most economical choice. It was quickly realised that no gate driver IC's were available that would drive a half-bridge on split supplies, at the same time interfacing easily with a comparator living off low-voltage rails also centred around ground. The IC track was abandoned and discrete solutions designed for both the gate drivers and the comparator.

The comparator provides two complementary current outputs to the two drivers, one of which floats with the high-side MOSFET.

### 3.1. Comparator

The comparator consists of a differential PNP pair, sourced from a ring source, feeding into a current difference amplifier. Back-to-back diodes connected across the collectors provide a path for excess difference current from the input stage.

The output current is set by the common base-emitter resistor. Response time of a typical circuit is around 50ns, with transition times around 3ns.

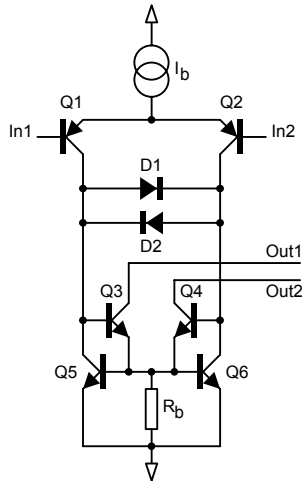

The comparator is conveniently operated from the same rails as the power section, obviating the need for a separate low-voltage supply. Turning off the tail current also cuts the output currents and inactivates the amplifier. Activation and deactivation of the amplifier happens with virtually no audible clicks.

### 3.2. Gate driver

For power levels below 200W, a good gate driver can be built with two PNP transistors. One is the controlling switch and doubles as the charge driver. The other is an active load to discharge the gate. Switching speeds are kept modest, at 100ns going up and 40ns coming down, greatly reducing generated EMI.

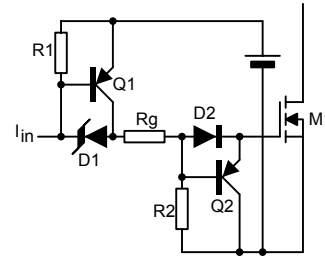

For higher powers, MOSFET gate charges become too large to be handled by this simple circuit. With two extra transistors per gate driver, amplifiers up to and above 1kW have been built.

The core circuit of a finished amplifier contains only 12 small-signal transistors and two power FETs. One has good reasons for believing simpler is not possible.

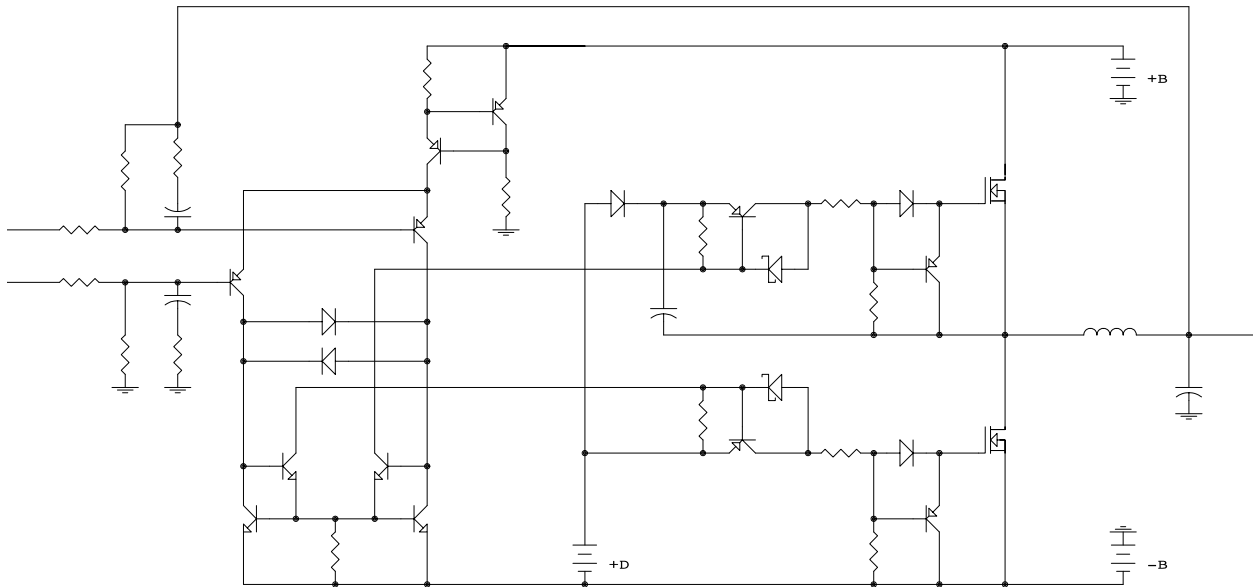

The control circuit is shown as a second order circuit configured as a differential input. A difference amplifier with two op amps can be added to the inputs to complete an instrumentation amplifier having high and equal input impedances.

**4. RESULTS**

**4.1. 100W amplifier with passive control.**

**4.1.1. Frequency response for 3 ohm, 6 ohm and open circuit loads**

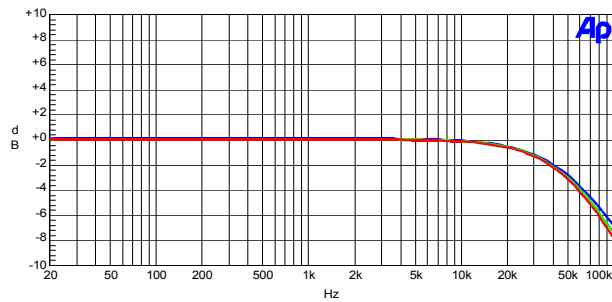

**4.1.2. Output impedance**

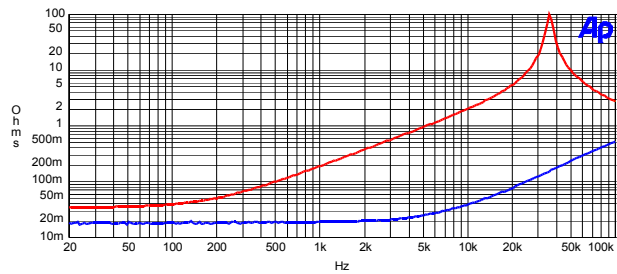

The blue curve is measured with the amplifier operating. For information, the red curve shows the output impedance of the LC filter alone. This confirms that the amplifier has good control even at the physical resonance frequency of the output filter.

**4.1.3. Distortion versus power at 1kHz**

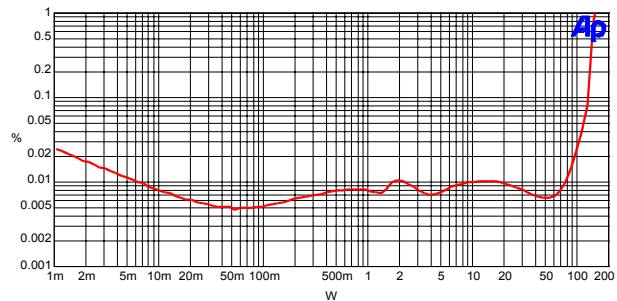

0.02% at 1kHz appears modest until it is realised that the same performance is held across the audio band.

#### 4.1.4. Distortion versus frequency

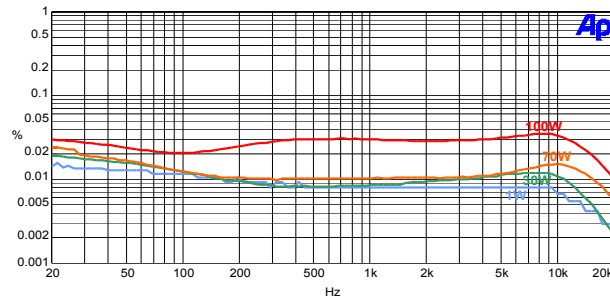

#### 4.2. 100W amplifier with 4<sup>th</sup> order active control

The following 1kHz THD plot was taken on an amplifier with 2 active orders added to the basic circuit.

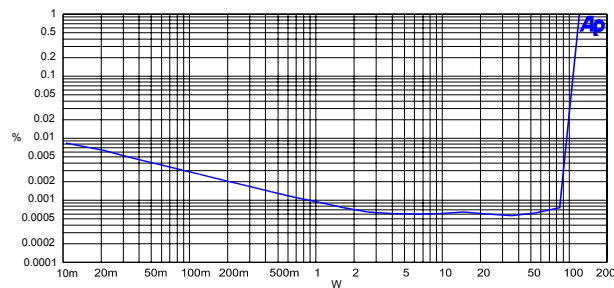

The resulting distortion levels are unprecedented for this type of amplifier.

## 5. CONCLUSIONS

A simple modulation method for class D audio amplifiers was presented that realises fully load-independent response and otherwise good audio performance as well. A practical discrete class D circuit was presented. Both the control method and the discrete implementation are believed to be the simplest possible. Minor increases in complexity readily pay off in significant performance improvements.

## 6. ACKNOWLEDGEMENTS

The author would like to thank his colleagues Renaud the Saint Moulin and Georges Aerts for their patient support in planning, execution and marketing and for their faith in the project.

## 7. REFERENCES

- [1] van der Hulst, Paul; Veltman, Andre; Groenenberg, Rene, "An Asynchronous Switching High-end Power Amplifier", Presented at the 112th AES Convention, Preprint 5503
- [2] Frederiksen, Thomas; Bengtsson, Henrik; Nielsen, Karsten, "A Novel Audio Power Amplifier Topology with High Efficiency and State-of-the-Art Performance", Presented at the 109th AES Convention. Preprint 5197