

High Efficiency Self Contained Amplifier Module



Image is for illustrative purposes only. Please refer to product description.

Highlights

- High efficiency
- Universal mains operation
- Flat, fully load-independent frequency response
- Low output impedance
- Very low, frequency-independent THD
- Very low noise

Features

- Two channel amplifier
- 5W standby SMPS
- Advanced over current protection
- External controlled operation
- Auto-switching (115/230V)
- Low weight: 575g.
- Compact: 170 x 105 x 42mm

Applications

- Monitor loudspeakers for recording and mastering studios
- Audiophile power amplifiers for professional and consumer use.
- Public address systems
- Active loudspeakers

Introduction

The NC252MP amplifier module incorporates a low power standby power supply (meets 2013 ERP Lot 6 0.5W requirements), a highly efficient switch mode power supply and a high-performance Class D amplifier in one compact and easily applicable power brick.

The amplifier used in the NC252MP is a self-contained high-performance class D amplifier intended for a wide range of audio applications, ranging from public address systems to ultrahigh-fidelity replay systems for studio and home use. Chief distinguishing features are flat frequency response irrespective of load impedance, nearly frequency independent distortion behaviour and very low radiated and conducted EMI. Control is based on a phase shift controlled self-oscillating loop taking feedback only at the speaker output.

The main SMPS providing the power for the amplifier is a compact, high power, highly efficient, regulated half bridge converter with synchronous rectification on the main output rails. These properties make this technology ideal for powering Class D audio amplifiers.

For applications requiring a standby mode, a low power standby SMPS also has been integrated into this product. To achieve universal mains input compatibility this SMPS features an automatic input voltage doubler.

The Hypex Channel Extension connector provides for an additional low power tweeter amplifier channel.

Please make sure you always download the latest datasheet from our website.

Contents

Highlights	1
Features	1
Applications	1
Introduction	1
Contents	2
1 Safety precautions	3
1 Précautions de sécurité	3
2 The NC-MP Series	4
3 Electrical Specifications	5
3.1 Power Specifications	5
3.2 Standby SMPS	5
3.3 Main SMPS	5
3.4 NCORE® Amplifier Specifications	6
3.5 NCORE® Amplifier Audio IO Characteristics	7
3.6 Timing Specifications	8
4 Environmental Specifications	9
4.1 Heat dissipation	9
5 Product Markings	9
6 IO Specifications	10
6.1 Power Supply Enable	10
6.2 Amplifier Mute	10
6.3 DC-Error	10
6.4 Power Good	10
6.5 Amplifier Clip Indicator	10
6.6 Temperature Readout	11
7 Connector Pinouts	12
7.1 H-Box connector	12
7.2 H-Bus connector	13
7.3 H-Channel extension	13
7.4 Loudspeaker Connector	13
7.5 AC Connector Specification	13
8 Typical Performance Graphs	14
9 Dimensions	15
9.1 Drill pattern	17
10 Bridge-tied load (BTL)	18
10.1 Typical Performance Graphs BTL	18
11 Safety compliance	19
12 Revisions	20
13 Disclaimer	20

1 Safety precautions

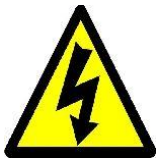

This module operates at mains voltage and carries hazardous voltages at accessible parts. These parts may never be exposed to inadvertent touch. Observe extreme care during installation and never touch any part of the unit while it is connected to the mains.

Disconnect the unit from the mains and allow all capacitors to discharge for 10 minutes before handling it.



Attention: Observe precautions for handling electrostatic sensitive devices. This module uses semiconductors that can be damaged by electrostatic discharge (ESD).

Damage due to inappropriate handling is not covered by warranty.

This product has no user-serviceable parts.



This symbol indicates the presence of hazardous voltages at accessible conductive terminals on the board. Parts that are not highlighted in red may also carry voltages in excess of 120 Vdc!

Warning: To reduce the risk of fire or electric shock, do not expose this apparatus to rain or moisture.

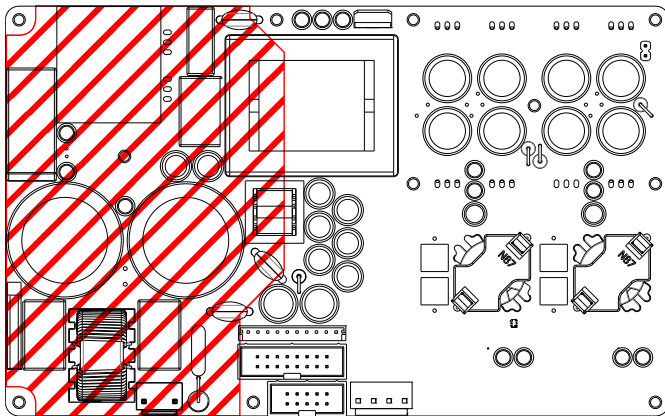

This is a Safety Class 2 device. When mounting the module in an enclosure, a minimum safety distance of 6mm from the module to all possible conducting parts must be ensured to keep compliance with Safety Class 2. All parts highlighted in red carry hazardous voltages. This includes parts on the top and the bottom of the board.

When this module is mounted in a tight space there needs to be at least 6mm clearance or a layer of insulation with a minimum thickness of 0.5mm between the top of the transformer and the housing.

1 Précautions de sécurité



Ce module est sous tension secteur et certaines de ses pièces accessibles sont sous une tension dangereuse. Ces pièces doivent dans tous les cas être protégées contre contacts accidentels. Lors de l'installation, une prudence extrême s'impose. Ne jamais toucher les pièces du module quand celui-ci est relié au secteur. Isoler l'appareil du secteur et attendre 10 minutes pour laisser à tous les condensateurs le temps de se décharger avant de le manipuler.



Attention : Respecter les consignes de sécurité pour la manipulation d'appareils sensibles aux courants électrostatiques. Ce module est pourvu de semi-conducteurs qui peuvent être endommagés par les décharges électrostatiques (DES).

Les dommages causés par un usage non approprié sont exclus de la garantie.

Ce produit ne contient aucune pièce devant être entretenue par l'utilisateur.



Ce symbole indique la présence de tensions dangereuses aux broches de raccordement accessibles sur la carte. Les pièces non marquées en rouge peuvent être elles aussi sous une tension supérieure à 120 VCC.

Avertissement: Pour réduire les risques de choc électrique, ne pas exposer cet appareil à la pluie ou l'humidité.

1. Read these instructions.
2. Keep these instructions.
3. Heed all warnings.
4. Follow all instructions.
5. Do not use this apparatus near water.
6. Protect the power cord from being walked on or pinched, particularly at plugs, convenience receptacles, and the point where they exit from the application.
7. Only use attachments/accessories specified or approved by the manufacturer.
8. Unplug this apparatus during lightning storms or when unused for long periods of time.
9. Refer all servicing to qualified service personnel. Servicing is required when the apparatus has been damaged in any way, liquid has been spilled or objects have fallen into the apparatus, the apparatus has been exposed to rain or moisture, does not operate normally or has been dropped.
10. Don't run any cables across the top or the bottom of the module. Apply fixtures to cables to ensure that this is not compromised.
11. Observe a minimum clearance of 6mm with all possible conducting parts (housing etc.).
12. Natural convection should not be impeded by covering the module (apart from the end applications housing).
13. Before using this product, ensure all cables are correctly connected and the power cables are not damaged. If you detect any damage, do not use the product.
14. Changes or modifications not expressly approved by Hypex Electronics will void compliance and therefore the user's authority to operate the equipment.
15. Service or modifications by any person or persons other than by Hypex Electronics authorized personnel voids the warranty.

2 The NC-MP Series

The NC-MP series is a range of mains powered NCORE® amplifiers both single and dual channel. Next to the mains powered modules, this range of modules also include a single channel add-on module. This module can be used to add one extra channel to a mains powered module. In the next table, there is an overview of the different models and their output power.

Model	Single channel, 4 Ohm	Dual channel, 4 Ohm
NC122MP	-	2 x 125 W
NC250MP	1 x 250 W	-
NC252MP	-	2 x 250 W
NC500MP	1 x 500 W	-
NC502MP	-	2 x 500 W
NC100HF	Hypex Channel Extension for tweeter	

The NC-MP is an all-in-one module, designed to be applied in a single module configuration and is certified as such. If a multi NC-MP setup is desired, one should take care of EMI, EMC, inrush currents and other related phenomena.

Evaluation board

For quick and easy evaluation, Hypex offers a special connection kit. This kit is specifically designed to make it easy to evaluate the new NCxxxMP series mains powered NCORE® modules. Furthermore, the NC100HF can be easily connected using a 8-pin box interface cable. A 10-pin JST interface cable is included to connect the NC100HF with the NCxxxMP. The breakout board features three Molex Micro-Fit 3.0 connectors for audio input signals (Molex cable-end part no: 43025-0400). The evaluation board comes with 10mm nylon spacers which can be used to mount the board using M3 screws. For more information, go to our website.

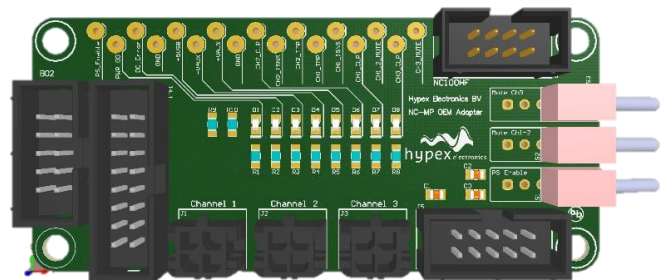

Cables

In addition to this evaluation board, Hypex offers cable sets to interface between the modules and the application. These cables have a standardized length. For more information, visit our website.

3 Electrical Specifications

3.1 Power Specifications

Parameter	Remarks	Symbol	Min	Typ	Max	Unit	Note
High Line Input Voltage	-	V _B	200-240Vac ±10%			Vac	1)
Low Line Input Voltage	-	V _{B,FP}	100-120Vac ±10%			Vac	1)
Line Input Frequency	-	f	47		63	Hz	1)
Fuse rating	250Vac, slow blow			6.3		A	2)

Note 1: The unit will automatically switch to the correct line input configuration at start up. Operation beyond these limits may result in irreversible damage.

Note 2: Fuse is soldered on the PCB and is therefore not user replaceable.

3.2 Standby SMPS

The standby power supply is immediately active upon connection to the mains and can therefore be used to power external control circuitry and to operate the PS Enable pin.

Parameter	Remarks	Symbol	Min	Typ	Max	Unit	Note
Output voltage	-	V _{OUT}	4.9	5	5.1	Vdc	
Output current	Continuous	I _{OUTMAX}	-	-	1	A	1)
Output current	For ERP compliance (<0,5W input power)	I _{OUTERP}	-	-	40	mA	
External capacitance	-		-	-	4700	µF	
Switching frequency		F _{SW.Stb}	-	65	100	kHz	
Efficiency	Full power	η	74	-	-	%	
Standby power	No load	P _{Stb}	-	-	0.12	W	
Output voltage Ripple		V _{RRIPPLE}	-	-	0.1	V	

Note 1: Protected against shorting and overloading. Power supply will automatically recover when overcurrent condition is removed.

3.3 Main SMPS

Parameter	Remarks	Symbol	Min	Typ	Max	Unit	Note
Efficiency	Full power	η	90			%	
Idle Losses	230 Vac, 50 Hz	P ₀	-	8.5	-	W	
In-rush current	5Ω In-rush NTC, worst-case	I _{Inrush}			75	A	
Switching frequency		F _{SW}	80	-	120	kHz	
Power consumption	Full power amplifier, 0.5A Vaux, 1A Standby	P _{max}	-	-	650	W	
Output Voltage Vaux	Symmetric power supply	V _{AUX}	±19	±20	±21	Vdc	
Output Current Vaux	Per rail	I _{AUX}	-	-	1	Adc	1)
External capacitance	-		-	-	2200	µF	

Note 1: The Vaux outputs are protected against accidental short circuits through a latched protection. When a short circuit on Vaux is detected, the DC Error protection is activated. See section 6.3 “DC-Error” for more information. Warning: the module may sustain damage after several repeated short circuit cycles.

3.4 NCORE® Amplifier Specifications

Parameter	Remarks	Symbol	Min	Typ	Max	Unit	Note
Max Output Power	1KHz, THD=1%, All channels driven. Per channel.	$P_{R, 2\Omega}$	-	-	180	W_{rms}	1)4)
		$P_{R, 4\Omega}$	-	-	250	W_{rms}	1)
		$P_{R, 8\Omega}$	-	-	150	W_{rms}	1)5)
Continuous Output Power	Per channel, 25°C ambient temperature.	$P_{R,cont}$	-	50	-	W_{rms}	2)
Distortion	<10Hz-20kHz AES17 $P_{out} < P_{R}/2$	THD+N	-	0.0015	0.0024	%	3)
	<10Hz-20kHz AES17 $P_{out} = 1W$		-	-	0.002	%	3)
CMRR			-	71	-	dB	
Signal-to-Noise Ratio	<10Hz-20kHz AES17		-	121	-	dB	
Output Noise	Unwtd, <10Hz-20kHz AES17, 0Ω termination	U_N	-	-	40μ	V	
Crosstalk	1KHz, P_{out} 10W / 4Ω, 0dB rel.			-105		dB	
Output Impedance	$f < 1kHz$	Z_{OUT}	-	-	2.5	mΩ	
	$f < 20kHz$		-	-	5.0	mΩ	
Power Bandwidth		PBW		20-35k		Hz	6)
Frequency Response	+0/-3dB. All loads.		10	-	50k	Hz	
Voltage Gain Buffered		A_v	25	25.5	26	dB	7)
Voltage Gain Unbuffered		A_v	11.5	12	12.5	dB	7)
Efficiency	Full power	η		92	-	%	
Idle Losses	Per channel	P_0	-	3.5		W	
Current Limit per Ch	Hiccup after limiting 40ms		-	17.5	-	A	

Note 1: The stimulus signal is a continuous 1 kHz sine wave. The true rms output voltage is measured across a load resistor. Max output power is time limited due to thermal properties.

Note 2: Typically, this is 1/5 of the peak output power. Apply sufficient cooling.

Note 3: An Audio Precision AES17 20 kHz is used during this measurement.

Note 4: Current limited.

Note 5: Voltage limited

Note 6: Dielectric losses in the output capacitor limit long term (>30s) full-power bandwidth to 5kHz.

Note 7: Factory default the module has an input buffer with a gain of 13.5 dB, for a total gain of 25.5dB. For modules revision 04xx or higher this buffer can be bypassed as explained in section 3.5 "Input buffer and gain"

3.5 NCORE® Amplifier Audio IO Characteristics

Parameter	Remarks	Symbol	Min	Typ	Max	Unit	Note
Input Impedance buffered	Either input to ground	Z _{IN}		47k		Ω	
Input Impedance unbuffered	Either input to ground	Z _{IN}		1.8k		Ω	
Loudspeaker impedance range		Z _{L,SE}	2	4	-	Ω	

Signal Coupling

To achieve optimal signal coupling, the audio signal inputs are all DC coupled. One must make sure that the connected application is free of DC offset.

Balanced or unbalanced

All Hypex modules are completely balanced for optimal performance. The modules can be connected to an unbalanced source. To do this correctly, please read our application notes: *'Dealing with legacy pin 1 problems'* and *'Amplifier signal input wiring'*.

Input buffer and gain

This module is equipped with an input buffer. From revision 04xx and up, it is possible to bypass the input buffer by removing R76, R162, R1002, R2002, R1003 and R2003 and placing a 0 ohm 0603 size resistor on placeholder R1001, R2001, R1004 and R2004. Placement of these resistors are shown in Figure 1 and Figure 2. Furthermore, changing the gain of the module is not supported.

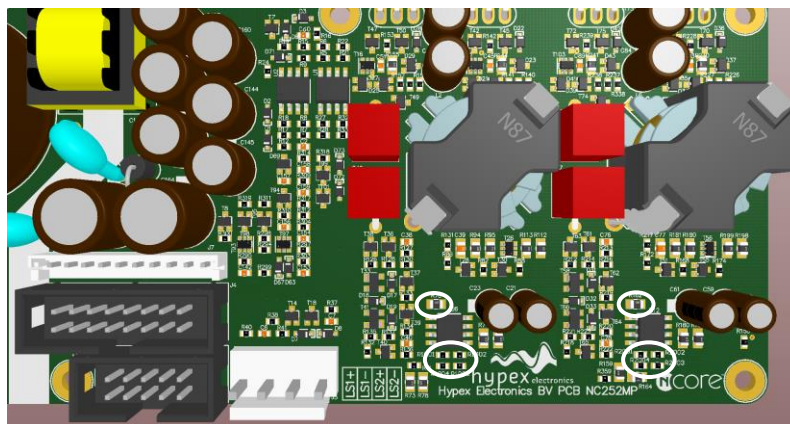

Figure 1 Placement of the bypass resistors

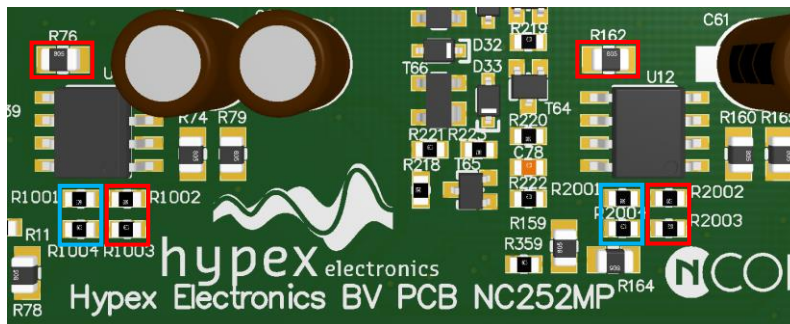

Figure 2 Resistors in the red squares need to be removed, resistors in the blue squares need to be added for unbuffered operation

Input sensitivity

Below a formula is given to calculate the balanced input signal level for a desired output level. An example is given using P_{RATED} 250W, Load 4Ω, Gain 25.6

$\frac{\sqrt{P_{RATED} * \Omega_{LOAD}}}{10^{\left(\frac{Gain}{20}\right)}} = Input V_{RMS}$	$V_{RMS} * \sqrt{2} = Input V_{Peak}$	$20 * \log_{10} \left(\frac{V_{RMS}}{0.7746} \right) = Input dBu$
↓	↓	↓
$\frac{\sqrt{250 * 4}}{10^{\left(\frac{25.6}{20}\right)}} = 1.66 V_{RMS}$	$1.66 * \sqrt{2} = 2.34 V_{Peak}$	$20 * \log_{10} \left(\frac{1.66}{0.7746} \right) = 6.61 dBu$

3.6 Timing Specifications

These timing specifications are measured at room temperatures, approximately 21°C, 230Vac.

Parameter	Remarks		Min	Typ	Max	Unit	Note
Standby start up delay	Time mains presence, till standby supply is within operational limits			10		ms	
Switching start up delay	Time mains presence, till all power supplies are within operational limits	230V		100	150	ms	
		115V		650	750	ms	
Output delay	Time delay to signal, from moment all power supplies are within operational limits			1500		ms	
Mute delay	Time delay to mute			25		µs	
Unmute delay	Time to unmute			120		µs	
Shutdown delay	Supply failure or Standby pin			550		µs	
Standby hold up	Supply hold up time in case of AC fail at 1A load, amplifier idle		1	2		s	1), 2)

Note 1: From version 04xx onward the standby voltage will be maintained until the bulk caps are fully discharged. The time this will take depends on the applied load connected to the standby power supply.

Note 2: Hold up time was measured starting at “Power Good” fail. The user could read out the failing “Power Good” and use the hold-up time to turn-off their µC or DSP.

4 Environmental Specifications

Parameter	Remarks	Symbol	Min	Typ	Max	Unit	Note
Ambient Temperature	Storage		-25	-	70	°C	
	Operation	T _{amb}	0	-	50	°C	
Heat-sink Temperature		T _{h,max}			95	°C	
Humidity	Max 85 percent relative humidity, non-condensing.						

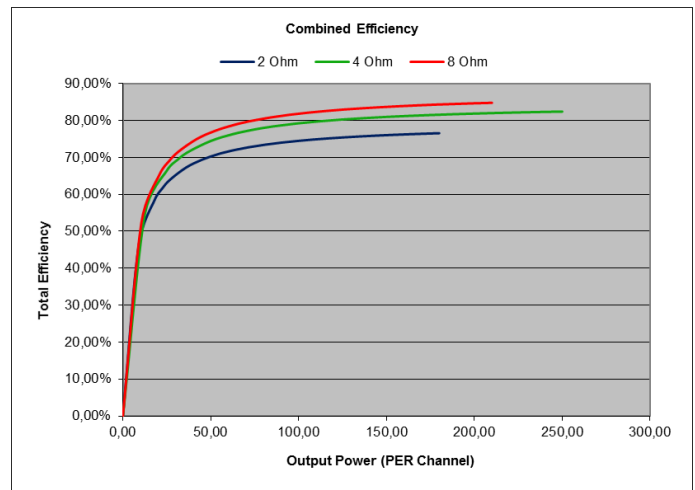
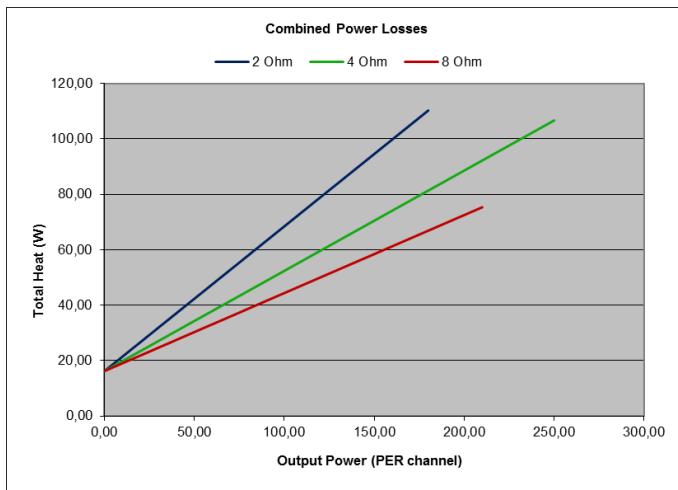

4.1 Heat dissipation

Class D amplifiers' known high efficiency often leads to a gross underestimation of the cooling required. Please apply adequate cooling to the module to ensure the module operates within specification. The following graphs provide an indication of the heat (in Watts) generated at different output levels. For more information regarding cooling, please refer to our application note "Thermal Design", available on our website. Defects caused by overheating due to poor thermal management are not covered by warranty.



5 Product Markings

Identification and supply ratings. This module has two marking stickers applied.

Model sticker	Identification sticker example
<p>Hypex Electronics BV</p> <p>NC252MP 100-120V~ / 200-240V~ 50-60Hz 650W MAX</p> 	 <p>Hypex Electronics B.V. Kattegat 8, NL-9723JP</p> <p>WK/YR: wyyy H04U004336-0400A12345-0123 NC252MP</p>

6 IO Specifications

6.1 Power Supply Enable

By asserting the PS Enable pin of the H-Bus connector the Main-SMPS is enabled. The Standby-SMPS is enabled from the moment that the module is connected to mains. Therefore the Standby-SMPS can be used to activate the Main-SMPS. When the Main-SMPS is powered up, the amplifiers will be enabled, providing there is no failure and Amplifier Mute is not asserted.

Parameter	Remarks	Symbol	Min	Typ	Max	Unit	Note
SMPS enabled	Logic High level		3,3	-	12	Vdc	¹⁾
SMPS in standby	Logic Low level		-	-	0.8	Vdc	

Note 1: The current (A) drawn can be calculated as follows: $(V_{pin} - 0.7) / 22000$

6.2 Amplifier Mute

By asserting either of the Amplifier Mute pins on the H-Box connector both amplifiers will be muted. This pin may be left unconnected if the mute function is not used.

Parameter	Remarks	Symbol	Min	Typ	Max	Unit	Note
Amplifier mute	Logic High level		3,3	-	12	Vdc	¹⁾
Amplifier un-mute	Logic Low level		-	-	0.8	Vdc	

Note 1: The current (A) drawn can be calculated as follows: $(V_{pin} - 0.7) / 10000$

6.3 DC-Error

If a DC component is present at either of the speaker outputs, the nFatal bus will be pulled down. This triggers the main SMPS to switch off and the DC Error to be activated. To reset the DC Error the module must be disconnected from mains for at least 10 minutes to allow the primary capacitors to drain. A DC Error does not affect the standby SMPS.

Parameter	Remarks	Symbol	Min	Typ	Max	Unit	Note
Collector voltage	Open collector output		-	-	50	V	
Collector current	Open collector output		-	-	100	mA	

6.4 Power Good

The Power Good will be activated if the main SMPS is functioning correctly. If the main SMPS is disabled, the Power Good pin is immediately released.

Parameter	Remarks	Symbol	Min	Typ	Max	Unit	Note
Collector voltage	Open collector output		-	-	50	V	
Collector current	Open collector output		-	-	100	mA	

6.5 Amplifier Clip Indicator

If a clip condition occurs the Amplifier Clip Indicator pin will be pulled to ground.

Parameter	Remarks	Symbol	Min	Typ	Max	Unit	Note
Collector voltage	Open collector output		-	-	50	V	
Collector current	Open collector output		-	-	100	mA	

6.6 Temperature Readout

A NTC is placed near the amplifier FET's and can be used to monitor the temperature. The NTC is connected to GND and accessible via the H-Box connector. The characteristics of the NTC are stated in the datasheet of the NTC manufacturer.

Parameter	Remarks	Symbol	Min	Typ	Max	Unit	Note
Resistor value	100 °C - 25 °C		0.9	-	10	kΩ	
Permissive Operating Current	25°C				0.31	mA	

NTC type: NCP18XH103J03RB

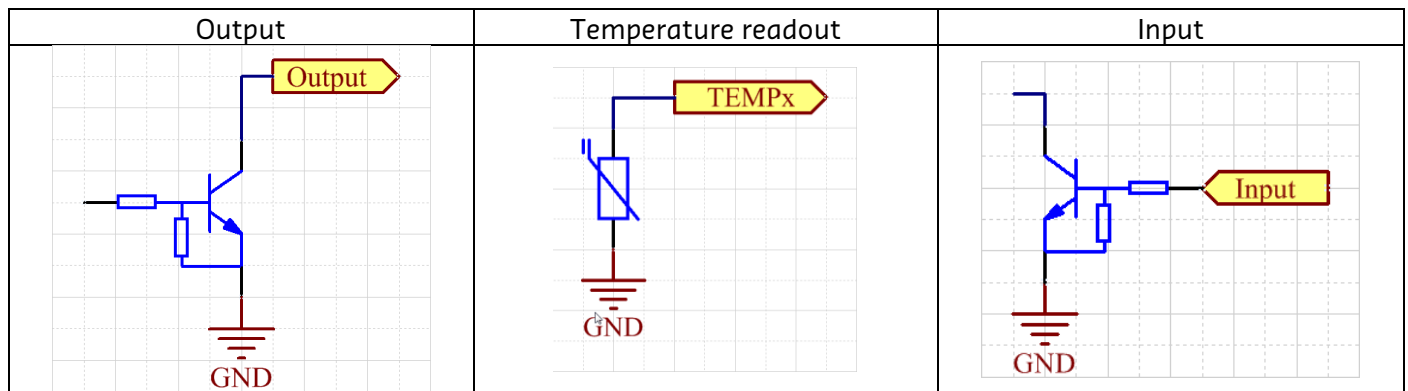

7 Connector Pinouts

This chapter describes the functional connectors of the amplifier module. A connector not stated in this chapter is only used for production or quality control and must remain unconnected in the end user appliance. The arrow points towards pin1 of the connector, for more information regarding a specific connector, please refer to the corresponding datasheet.

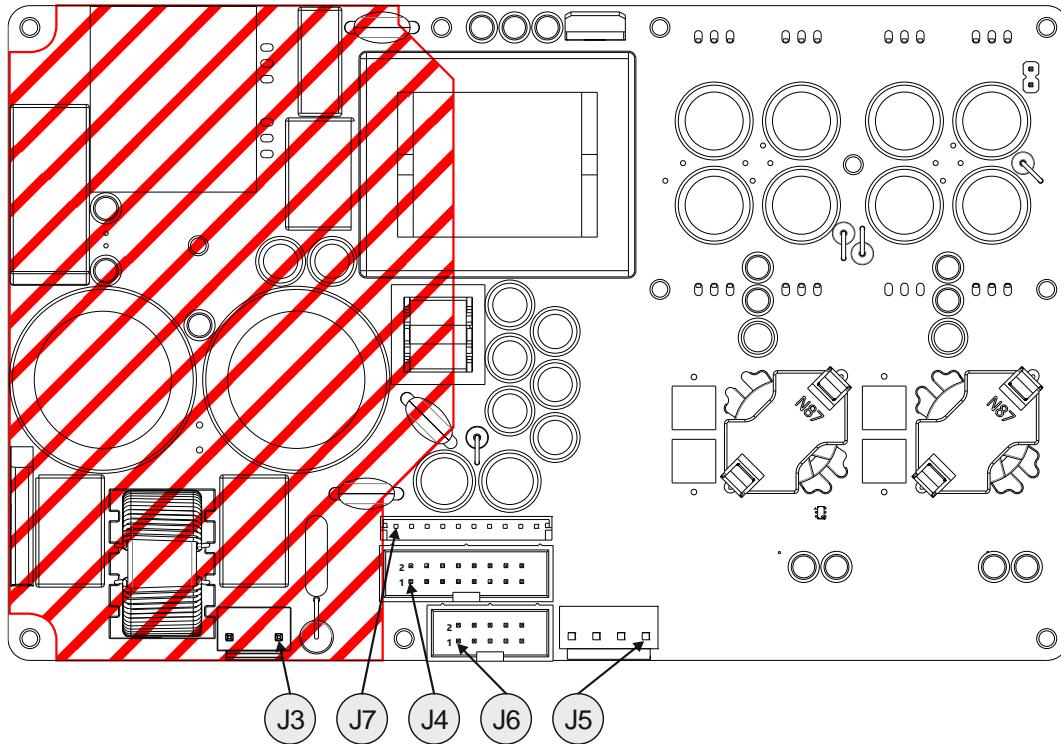

7.1 H-Box connector

Pin	Direction	Function	Remarks
J4.1	Input	CH1 In -	Inverting audio input Channel 1
J4.2	Input	CH1 In +	Non-inverting audio input Channel 1
J4.3	-	CH1 GND	Ground
J4.4	Input	Mute	Amplifier mute (both channels)
J4.5	Output	CH1 Clip	Clip indicator Channel 1
J4.6	Input	CH1 HWAddr	Not connected
J4.7	Output	CH1 ISense(1)	Not connected
J4.8	Output	CH1 Thermal	Temperature readout Channel 1
J4.9	Output	CH2 Thermal	Temperature readout Channel 2
J4.10	Output	CH2 ISense(2)	Not connected
J4.11	Input	CH2 HWAddr	Not connected
J4.12	Output	CH2 Clip	Clip indicator Channel 2
J4.13	Input	Mute	Amplifier mute (both channels)
J4.14	-	CH2 GND	Ground
J4.15	Input	CH2 In +	Non-inverting audio input Channel 2
J4.16	Input	CH2 In -	Inverting audio input Channel 2

Connector type equivalent: T821116A1S100CEU

Contact material: Brass, gold flash over nickel

7.2 H-Bus connector

Pin	Direction	Function	Remarks
J6.1	Output	V _{AUX}	Positive auxiliary supply
J6.2	Output	V _{AUX}	Negative auxiliary supply
J6.3	Output	V _{OUT,STANDBY}	Regulated standby supply
J6.4	-	GND	Ground
J6.5	n.c.	SDA (I ² C)	Not connected
J6.6	n.c.	SCL (I ² C)	Not connected
J6.7	Output	DC Error	DC Offset detected, power supply disabled.
J6.8	Output	Power Good	Power supply stable indicator
J6.9	Input	PS Enable	Power supply enable
J6.10	Reserved	Reserved	Not connected

Connector type equivalent: T821110A1S100CEU

Contact material: Brass, gold flash over nickel

7.3 H-Channel extension

J7

The Hypex Channel Extension interface is designed for use with a single NC100HF tweeter amplifier and may therefore not be used for other purposes.

Connector type: B10B-EH-A(LF)(SN)

7.4 Loudspeaker Connector

Pin	Direction	Function	Remarks
J5.1	-	LS2-	Cold Loudspeaker Output On-board Amp Channel 2
J5.2	Output	LS2+	Hot Loudspeaker Output On-board Amp Channel 2
J5.3	-	LS1-	Cold Loudspeaker Output On-board Amp Channel 1
J5.4	Output	LS1+	Hot Loudspeaker Output On-board Amp Channel 1

Connector type: B4P-VH(LF)(SN)

7.5 AC Connector Specification

v	Direction	Function	Remarks
J3.1	Input	Mains input	Neutral AC
J3.3	Input	Mains input	Phase AC

Connector type: B2P3-VH(LF)(SN)

8 Typical Performance Graphs

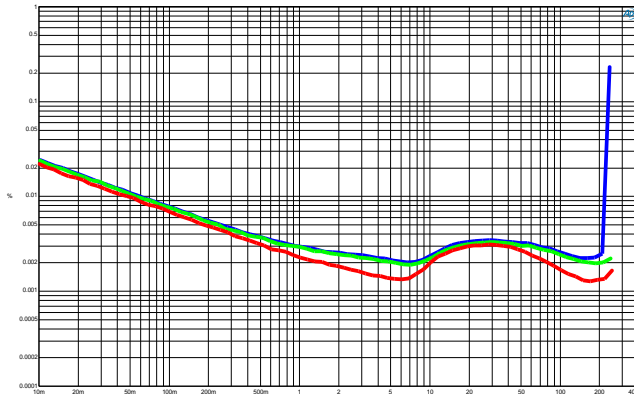

THD+N vs. power at 100Hz (blue), 1kHz (green) and 6kHz (red) (2Ω).

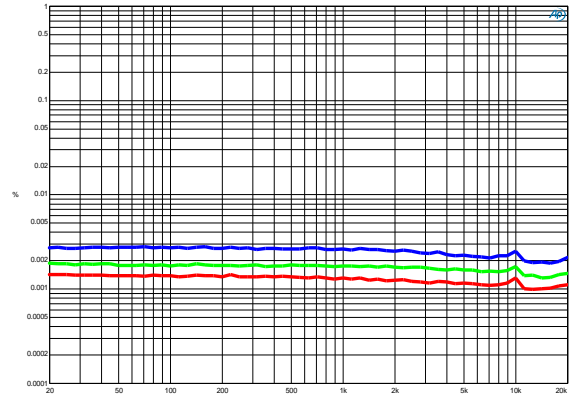

THD+N vs. Frequency at 1W in 2Ω (blue), 4Ω (green) and 8Ω (red).

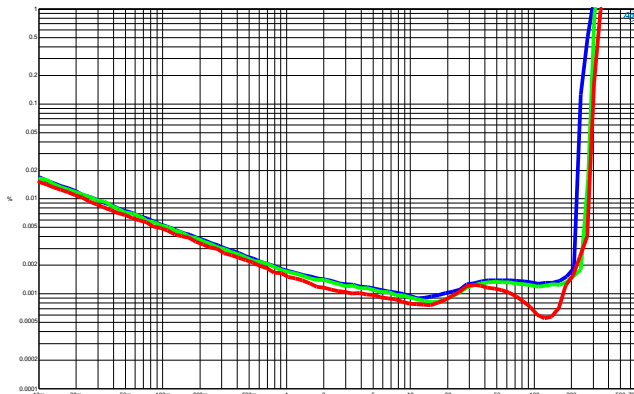

THD+N vs. power at 100Hz (blue), 1kHz (green) and 6kHz (red) (4Ω).

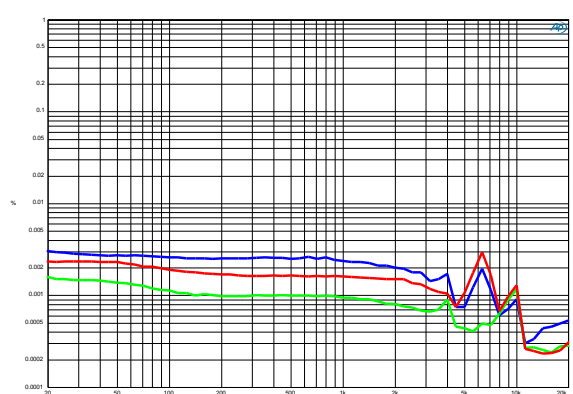

THD+N vs. Frequency at $P_R/2$ in 2Ω (blue), 4Ω (green) and 8Ω (red).

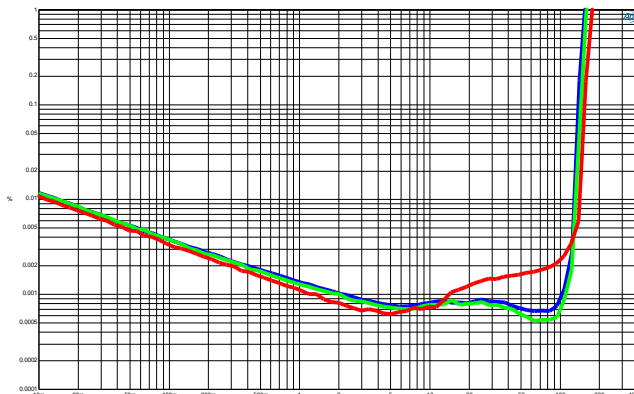

THD+N vs. power at 100Hz (blue), 1kHz (green) and 6kHz (red) (8Ω).

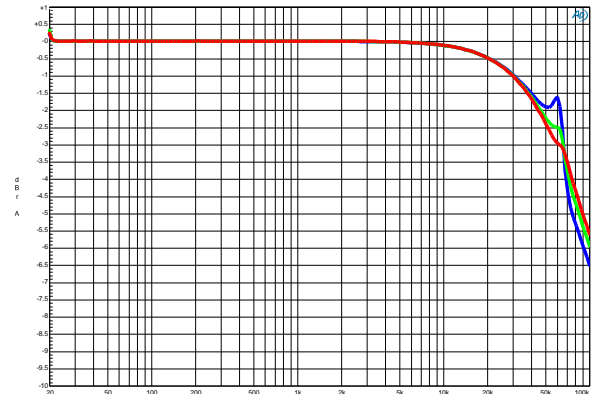

Frequency response in 2Ω (blue), 4Ω (green) and 8Ω (red).

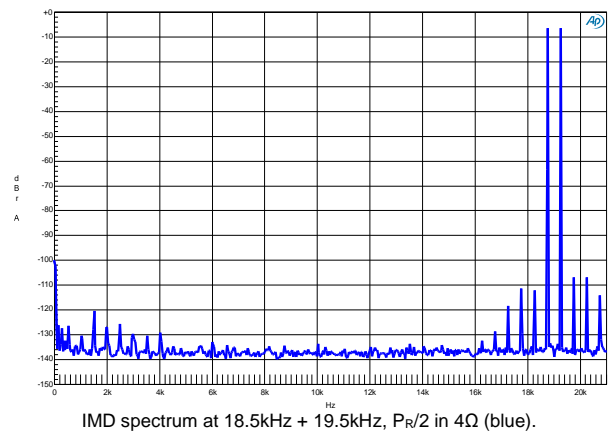
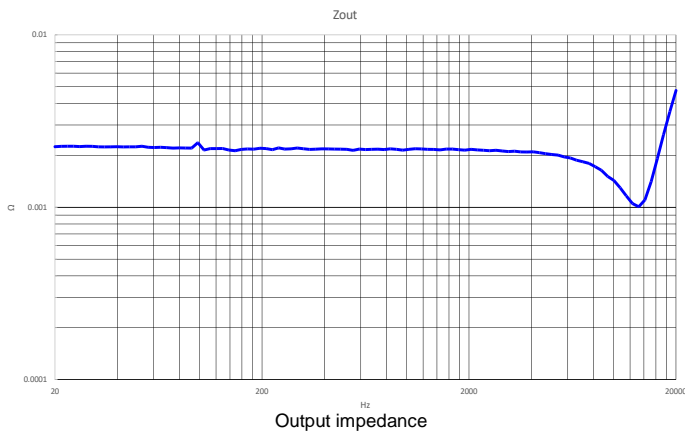

9 Dimensions

Parameter	Remarks	Symbol	Min	Typ	Max	Unit	Note
Height			-	42	44	mm	
Width			104.6	105	105.4	mm	
Length			169.6	170	170.4	mm	

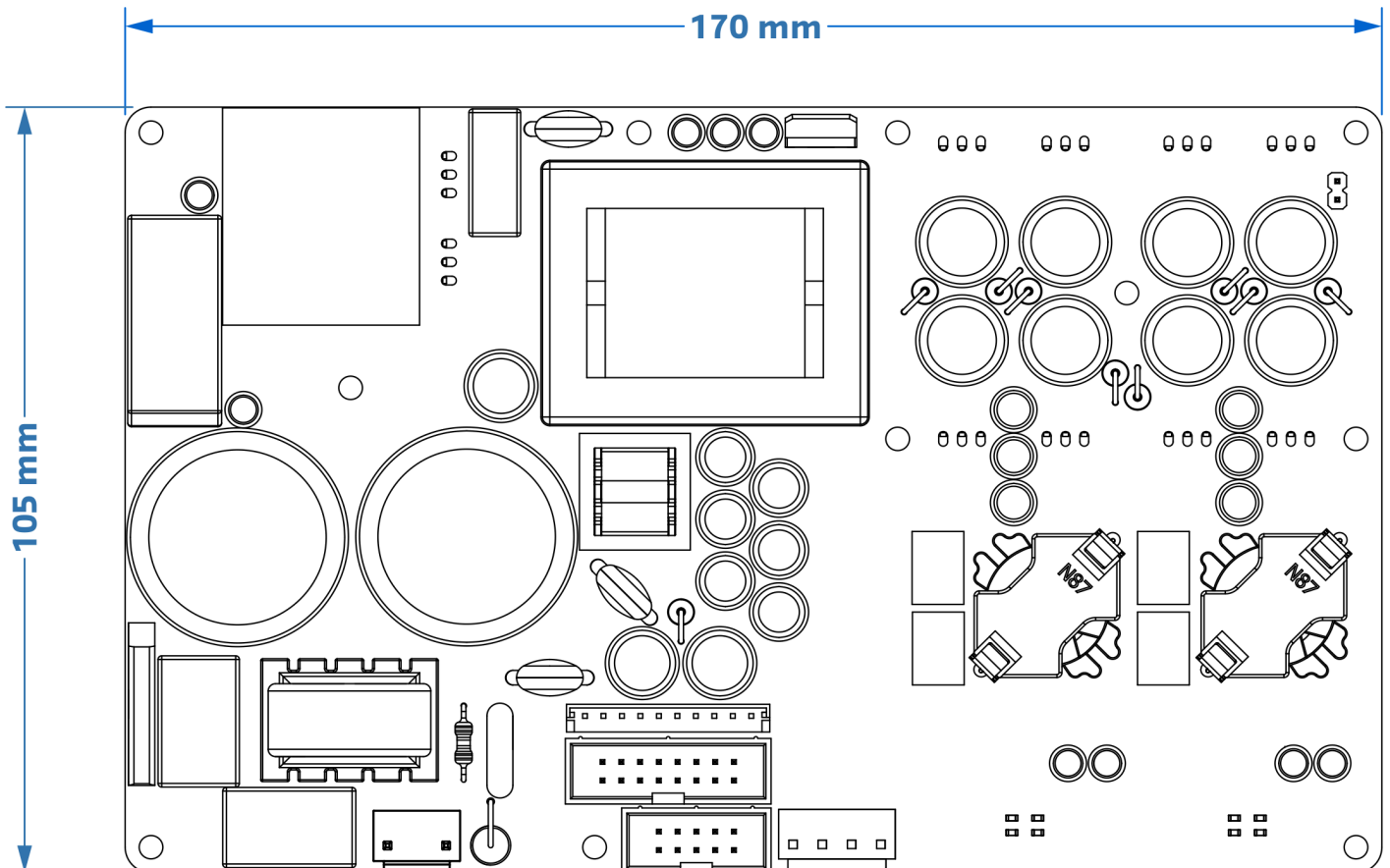

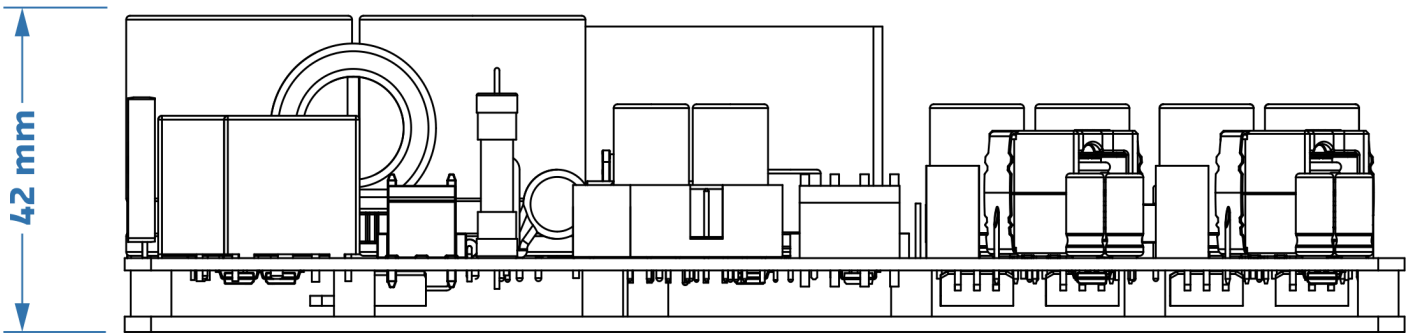

9.1 Drill pattern

If printed correctly (scale 100%, A4), the scale of the image below should be 1:1. You may use it as a model to drill holes in your casing. Please verify before drilling!

Maximum allowed protruding depth inside each spacer is 4mm. Spacer threads are M3. All fixture dimensions are subjected to $\pm 0.2\text{mm}$ tolerance.

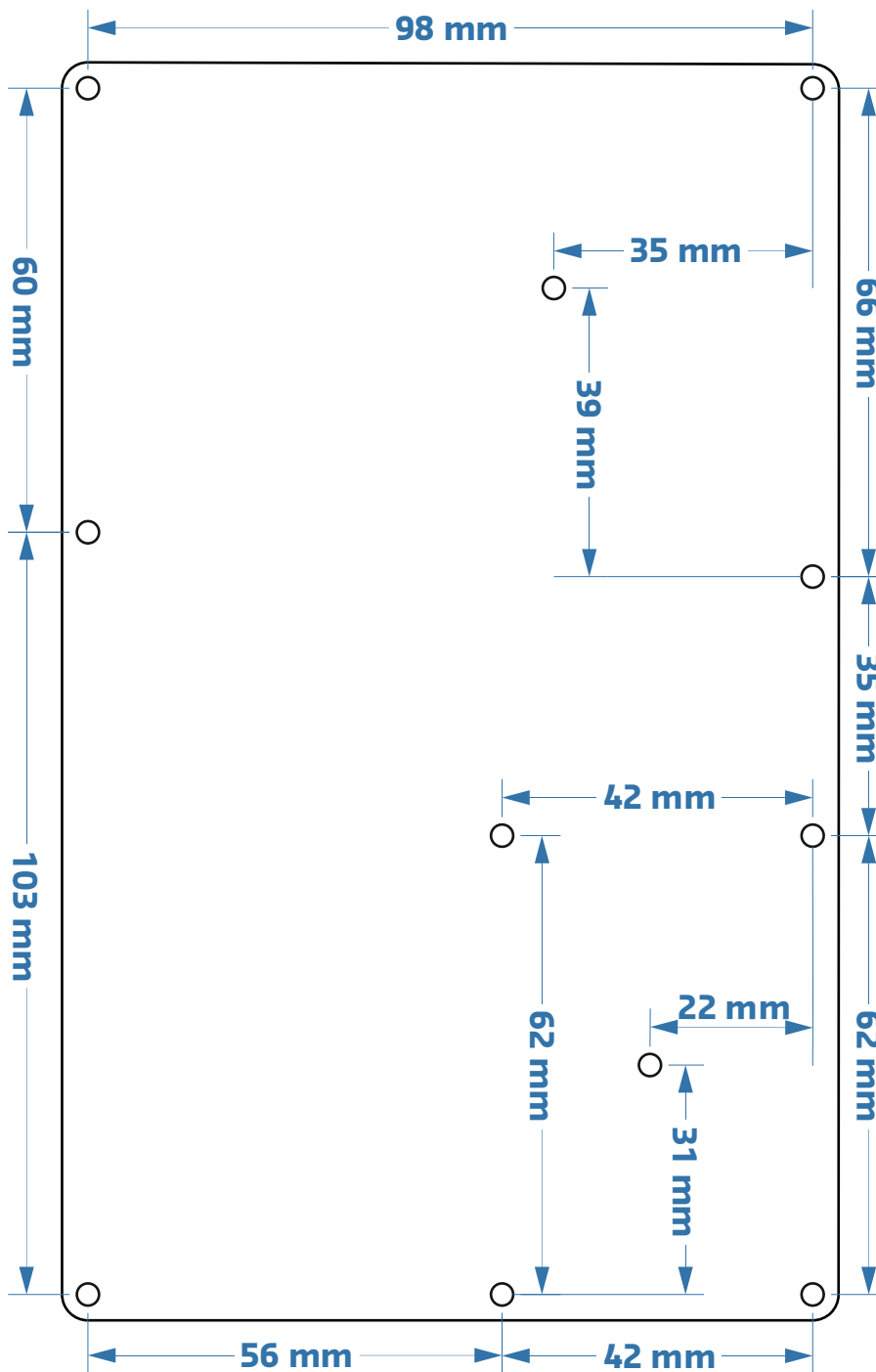

10 Bridge-tied load (BTL)

This two channel amplifier can be utilized in Bridge Tied Load configuration. This is especially useful for high impedance loads. In a bridge-tied load configuration, channel 1 is driving one side of a load and channel 2 is driving the other side of the load. The signal input of channel 2 is the inverted signal input of channel 1. Note that this does not affect the phase of the signal. A BTL configuration results in double the voltage swing across the load compared to a single-ended configuration where one side of the load is tied to an amplifier and the other side to ground.

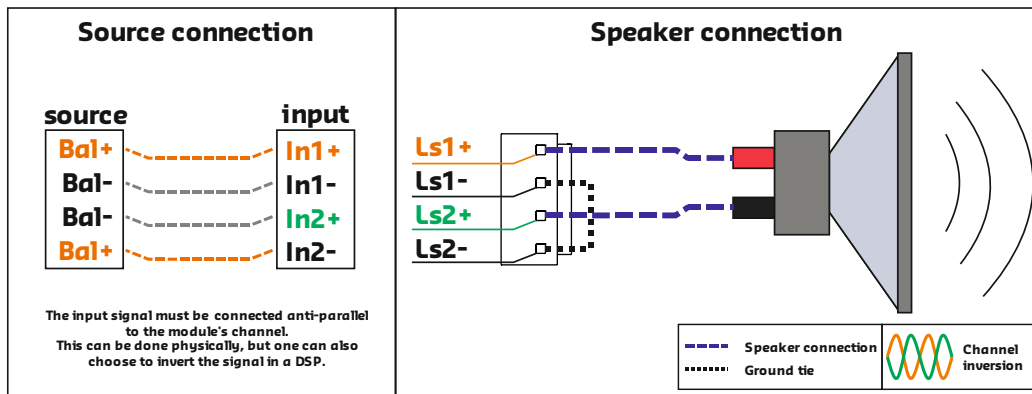

In the graphical representation above, the BTL principle is depicted. By inverting the signal input of the second channel, the output voltage amplitude is doubled. Please note that the negative (GND) output terminals are tied together. On the NC-MP modules, this is already implemented in the design and therefore these pins can be left unconnected.

In a bridge-tied load configuration, the load impedance which each amplifier channel 'sees' is half the characteristic impedance of the connected speaker. Therefore the minimum load in BTL configuration is 4Ω, however, we recommend to use only a BTL configuration with a load of 8Ω or higher.

Parameter	Remarks	Symbol	Min	Typ	Max	Unit	Note
Peak Output Power	1KHz, THD=1%, Bridge-tied load (BTL)	$P_{R, 4\Omega}$	-	-	400	W	
		$P_{R, 8\Omega}$	-	-	500	W	
Voltage Gain	Bridge-tied load (BTL)	A_v	31	31.5	32	dB	
Loudspeaker impedance range	Bridge-tied load (BTL)	$Z_{L,SE}$	4	8	-	Ω	

10.1 Typical Performance Graphs BTL

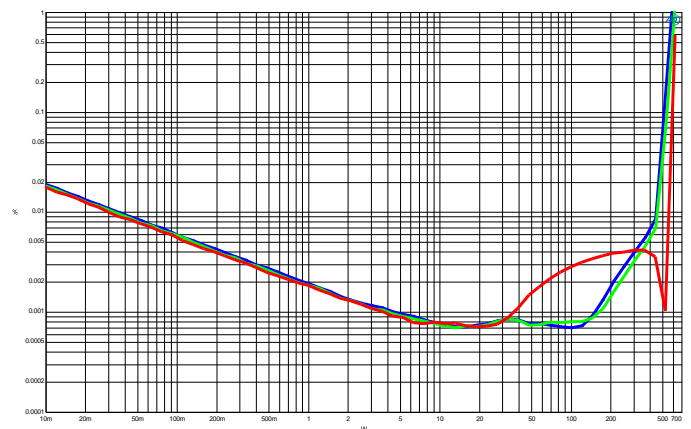
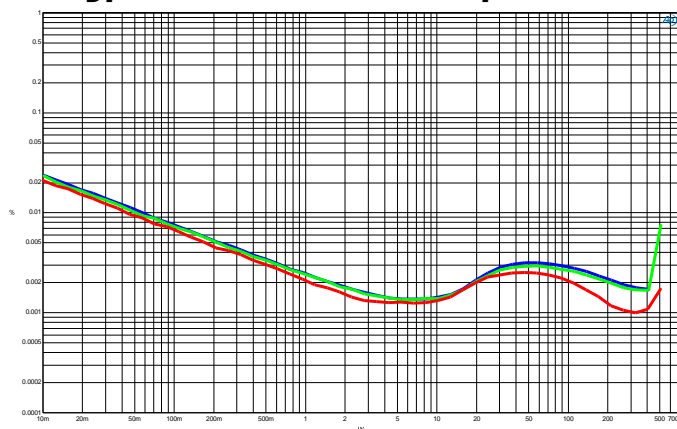

11 Safety compliance

The NC252MP revisions 0400 and higher is safety tested according to the following standards:

- IEC 60065:2014 + A11:2017
 - National deviations for CENELEC countries
 - National deviations for China
- IEC 62368-1:2014 + A11:2017
 - National deviations for CENELEC countries
 - National deviations for USA
 - National deviations for Canada
 - National deviations for New Zealand
 - National deviations for Australia
 - National deviations for Japan

Relevant standards

The NC252MP revisions 0400 and higher fulfils the requirements of:

- IEC60065:2014 + A11:2017
- IEC62368-1:2014 + A11:2017
- UL62368-1:2014 Ed.2
- CSA C22.2#62368-1:2014 Ed.2

Test procedure

- CB scheme IEC60065
 - Test laboratory: Intertek SEMKO
 - Ref. Certif. No: SE-100164M1
- CB scheme IEC62368-1
 - Test laboratory: Intertek SEMKO
 - Ref Certif. No: SE-108370M1

ETL listing

The NC252MP is an ETL listed component for the USA (UL62368-1:2014 Ed. 2) and Canada (CSA C22.2#62368-1:2014 Ed.2).

12 Revisions

Document revision	Module revision	Change log	Date
01	NC252MP 01xx	Pre-release version	Oct '16
02	NC252MP 02xx	Input buffer changed	Oct '16
03	NC252MP 02xx	Irregularity in the Hypex-box corrected: differential signal inputs were swapped, resulting in a 180° phase shift.	Dec '16
03	NC252MP 02xx	Information added for safety standards approval Multiple typographical inaccuracies revised Answers to frequently asked questions added	April '17
04	NC252MP 02xx	Signal to noise ratio corrected	June '17
05	NC252MP 04xx	Update to revision 04xx	Jan '19
06	NC252MP 04xx	Updated marking labels Added safety approbations Added dimension tolerances	Sep '19
07	NC252MP 04xx	Updated audio performance measurements to latest version Updated safety approbations	Feb '20
08	NC252MP 04xx	Updated product picture	March '20
09	NC252MP 04xx	Corrected typo in product markings	Dec '20
10	NC252MP 04xx	Added note to table 3.3 regarding short circuit protection on Vaux	May '21
11	NC252MP 04xx	Updated trademarks and HEXT description	Dec '21
12	NC252MP 04xx	Updated CB reference certificate for IEC62368-1	Aug '22
13	NC252MP 04xx	Updated IEC62368-1 and IEC60065 CB reference NO.	Jan '23

13 Disclaimer

All products, product specifications and data are subject to change without notice to improve reliability, function or design or otherwise.

Hypex Electronics BV, its affiliates, agents, and employees, and all persons acting on its or their behalf (collectively, "Hypex Electronics"), disclaim any and all liability for any errors, inaccuracies or incompleteness contained in any datasheet or in any other disclosure relating to any product.

This subassembly is designed for use in music reproduction equipment only. No representations are made as to fitness for other uses. Except where noted otherwise any specifications given pertain to this subassembly only. Responsibility for verifying the performance, safety, reliability and compliance with legal standards of end products using this subassembly falls to the manufacturer of said end product.

LIFE SUPPORT POLICY: Use of Hypex products in life support equipment or equipment whose failure can reasonably be expected to result in injury or death is not permitted except by explicit written consent from Hypex Electronics BV.