DSP3-224



Features

- Stereo inputs (XLR, RCA, digital)
- Four channel active filtering
- Compatible with MP series
- 3 programmable presets
- One FIR (2048 taps)
or 3 (1024 per channel) per preset
- Configurable Soft clip limiter
- Automatic source selection
- Automatic signal detection
- Optional IR remote control
- Master-slave operation

Applications

- Active speakers
- Active subwoofers
- PA systems
- Studio monitors

Introduction

The DSP3-224 is a high grade, stereo input, four channel DSP board to be used specifically with the Hypex MP series amplifiers. It can be expanded with an optional digital input board. The DSP boards can be used in master-slave configuration or can connect to a FusionAmp plate amp create a stereo 2.1 system. Three presets are available to store different filter settings, inputs and volume offsets. In each preset either one 2048 tap FIR filter right after the input, or three 1024 tap FIR filters on the output (one for each channel) can be implemented.

The four outputs are available on two Hypex HBOX connectors, making them easily connect to dual output MP modules (maximum of four modules, minimum of one module)

If 2-channel amplifiers are connected the outputs can be configured for BTL operation.

An optional infrared receiver board and a OLED display with infrared receiver board available for remote control.

NOTE: The DSP3-224 is powered through J12, J20 only passes control signals. So J12 should be connected to a NCxxxMP which has a power-supply. (J20 may also be connected to an NCxxxMP with power supply, but the power-supply of that module will not be used on the DSP3-224 board, only its control signals are passed).

Contents

Contents	2
1 Safety precautions	3
2 Block diagram	4
3 Electrical Specifications	5
3.1 Performance data	5
3.2 Gain table	6
3.3 Typical THD+N at maximum output power per module	6
3.4 Recommended Operating Conditions and Supply Currents	6
4 IO Specifications	7
4.1 Power Supply Enable	7
4.2 Amplifier Mute	7
4.3 DC-Error	7
4.4 Power Good	7
4.5 Amplifier Clip Indicator	7
5 Connector pinouts	8
5.1 DSP3-224 with DIGin3-322 connectors and controls	8
5.2 DSP3-224 board IO pins	10
5.3 DIGin3-322 IO pins	14
6 Features	15
7 DSP flow diagrams	17
8 Dimensions	18
9 Revisions	19
10 Disclaimer	19

1 Safety precautions



Attention: Observe precautions for handling electrostatic sensitive devices. This module uses semiconductors that can be damaged by electrostatic discharge (ESD).

Damage due to inappropriate handling is not covered by warranty.

This product has no user-serviceable parts.

1. Read these instructions.
2. Keep these instructions.
3. Heed all warnings.
4. Follow all instructions.
5. Do not use this apparatus near water.
6. Protect the power cord from being walked on or pinched, particularly at plugs, convenience receptacles, and the point where they exit from the application.
7. Only use attachments/accessories specified or approved by the manufacturer.
8. Unplug this apparatus during lightning storms or when unused for long periods of time.
9. Refer all servicing to qualified service personnel. Servicing is required when the apparatus has been damaged in any way, liquid has been spilled or objects have fallen into the apparatus, the apparatus has been exposed to rain or moisture, does not operate normally or has been dropped.
10. Don't run any cables across the top or the bottom of the module. Apply fixtures to cables to ensure that this is not compromised.
11. Observe a minimum clearance of 6mm with all possible conducting parts (housing etc.).
12. Natural convection should not be impeded by covering the module (apart from the end applications housing).
13. This product is to be used with Hypex NCxxxMP modules only.
14. Before using this product, ensure all cables are correctly connected and the power cables are not damaged. If you detect any damage, do not use the product.
15. Changes or modifications not expressly approved by Hypex Electronics will void compliance and therefore the user's authority to operate the equipment.
16. Service or modifications by any person or persons other than by Hypex Electronics authorized personnel voids the warranty.

2 Block diagram

This block diagram shows an overview of the technical architecture of the DSP3-224. Depending on the configuration the available inputs may vary. The default configuration has analogue XLR and RCA inputs. This can be expanded with a digital input board which includes AES, SPDIF and optical inputs. Furthermore, an optional IR receiver kit and oled-display are available.

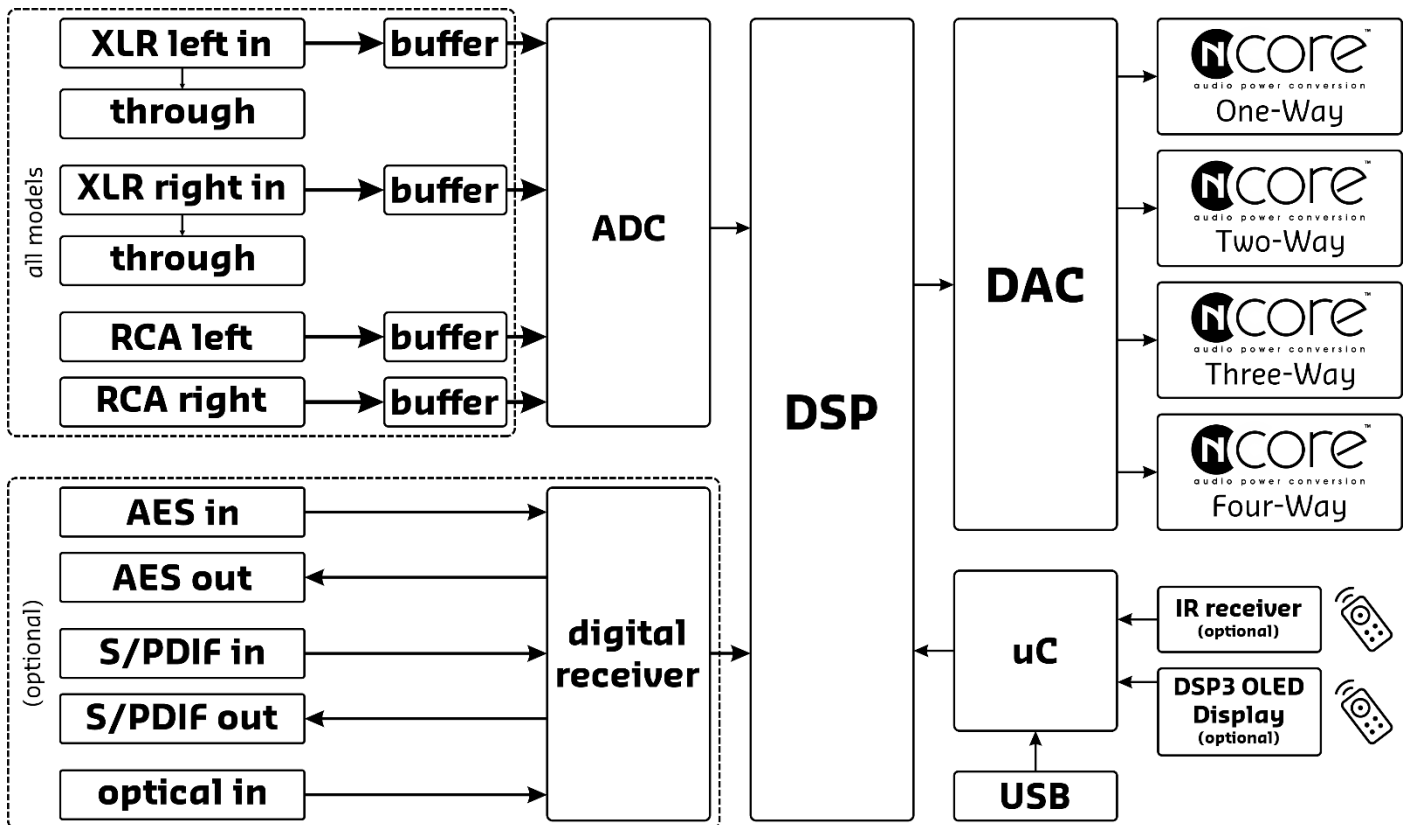

Figure 1: Block diagram

3 Electrical Specifications

3.1 Performance data

MBW=20kHz (20Hz-20Khz), unweighted, all filters set to unity, gain adjust 0dB unless otherwise noted

Item	Symbol	Min	Typ	Max	Unit	Notes
Input level	XLR	V _{IN}	18 (6.15)		dBu (V _{RMS})	Default gain setting (See p6.1)
	RCA		9 (2.18)			
Output level	All Channels	V _{OUT}		3.1	V _{RMS}	0 dBFS (differential) See gain table
Signal/Noise ratio	SNR		111.0		dB	Digital in
			109.0			Analogue in
Total harmonic distortion + noise	THD+N		-102.5		dB	Digital in, -1dBFS
			-100.0			Analogue in, -1dBFS
Input Impedance (DM) XLR	Z _{IN, DM}		44		kΩ	Differential mode
Input Impedance (CM) XLR	Z _{IN, CM}		2.2		MΩ	Common mode
Input impedance AES			110		Ω	
Input impedance RCA			44		kΩ	
Input impedance SPDIF			75		Ω	
Frequency Response (relative to 1kHz)		10		35k	Hz	+/- 0.1dB
DSP sampling rate	F _s		93.75		kHz	
ADC sampling rate	F _s		93.75		kHz	
Samplerate converter	F _s	32		216	kHz	All input rates converted to 93.75kHz
Optical input	F _s		48.00	96	kHz	
S/PDIF	F _s		48.00	192	kHz	¹⁾
AES	F _s		192.00	216	kHz	²⁾
Delay global (all channels)		0		74	mSec	Set in HFD software
Extra delay per channel		0		10		
CM Rejection Ratio	CMRR		-66.0		dB	All frequencies
Channel separation			-111.0		dB	Left/Right and inter- channel separation
Analogue latency			350		μs	
Digital latency			1.8		ms	96kHz input sample rate

Note 1 Recommended maximum S/PDIF samplerate 96kHz

Note 2 Recommended maximum AES/UBU samplerate 192kHz

3.2 Gain table

The output voltage of the DSP3-224 is determined by the input level required for the rated power at 8 Ohm of the amplifier module selected in the software. Depending on the selected amplifier a correction is applied to the maximum output level of the respective channel.

Amp module	Output power @ 8 Ohm (W)	Amplifier gain (dB)	DSP output @0dB (V _{RMS})
			Channel 1 to 4
NC250MP	130	25.5	1.71
NC500MP	270	25.5	2.47
NC122MP	75	25.5	1.30
NC252MP	200	25.5	2.12
NC502MP	350	25.5	2.81
NC100HF	100	19.6	2.96
NCAS500	400+100		1.50
NCAS1000	800+200		2.12
NC52MP	25	25.5	1.00
NCx100EXT	100	20.5	2.52
NCx102EXT	100	20.5	2.52

3.3 Typical THD+N at maximum output power per module

Amp module	DSP output (V _{RMS})	THD+N @max. output power (0dBFS) ¹⁾			
		Ch1 (dB)	Ch2 (dB)	Ch3 (dB)	Ch4 (dB)
NC52MP	1.00	-101.0	-100.5	-101.0	-101.0
NC122MP	1.30	-103.0	-102.5	-103.0	-103.0
NCAS500	1.50	-104.0	-103.5	-104.0	-104.0
NC250MP	1.71	-104.0	-104.0	-104.5	-104.0
NC252MP, NCAS1000	2.12	-103.0	-103.0	-103.5	-103.0
NC500MP	2.47	-100.0	-99.0	-102.0	-101.5
NCx100EXT, NCx102EXT	2.52	-100.0	-99.0	-101.5	-101.5
NC502MP	2.81	-99.0	-98.0	-99.5	-98.0
NC100HF	2.96	-98.5	-97.5	-99.0	-97.5

Note 1 Measured at 96kHz sample rate, 1kHz signal, AES17(20kHz) filter, unweighted

3.4 Recommended Operating Conditions and Supply Currents

Parameter		Symbol	Min	Typ	Max	Unit	Note
Supply voltage	Symmetric supply (+/-)	V _{Aux}	16.0 0	20	21.00	V	
Supply current (+)		I _{Aux}	64		57	mA	1)
	With optional DigIn		91		86	mA	1)
Supply current (-)		I _{Aux}	35		35	mA	
	With optional DigIn		62		63	mA	
Logic supply voltage		V _{logic}	4.75	5	5.25	V	
Logic supply current	DSP active	I _{Run}	203		195	mA	2)
	DSP in standby mode	I _{Stb}	19		17	mA	2)
	With optional DIGin3	I _{Run2}	241		225	mA	3)
	DSP in low-power mode	I _{LowPower}	110		105	mA	4)
	DSP in standby mode	I _{Stb2}	23		21	mA	1)

Notes: see next page.

Note 1 Maximum current value is drawn at minimum input supply voltage, minimum current value is drawn at maximum input supply voltage (due to DC-DC converters).

Note 2 No options attached.

Note 3 No FAN attached.

Note 4 Low-Power mode is only available when optional DIGin3 module is attached, FAN is off.

4 IO Specifications

4.1 Power Supply Enable

When the DSP3-224 board is switched out of standby mode, the PS Enable pin on both the H-Bus connectors are asserted and the Main SMPS of the connected NCxxxMP modules are enabled. A NCxxxMP is mandatory on HBUS1 and HBOX1. A connected NCxxxMP on HBUS1 will provide standby power and V_{aux} .

Parameter	Direction	Remarks	Min	Typ	Max	Unit	Note
SMPS enabled	Output	Active HIGH	2.7	-	3.3	V_{DC}	
SMPS in standby			0.0	-	0.6	V_{DC}	

4.2 Amplifier Mute

By asserting either of the Amplifier Mute pins on the H-Box connectors all connected amplifiers are muted. These pins are controlled by the DSP3-224.

Parameter	Direction	Remarks	Min	Typ	Max	Unit	Note
Amplifier mute	Output	Active HIGH	2.7	-	3.3	V_{DC}	
Amplifier un-mute			0.0	-	0.6	V_{DC}	

4.3 DC-Error

If a DC component is present at either of the speaker outputs of the NCxxxMP, the nFatal bus is pulled down. This triggers the main SMPS to switch off and the DC Error to be activated. The red Protection LED will light up when a DC error is detected.

Parameter	Direction	Remarks	Min	Typ	Max	Unit	Note
DC error	Input	Active LOW	0.00	-	0.66	V_{DC}	
No DC error			2.64	-	3.30	V_{DC}	

4.4 Power Good

The Power Good signal will be activated if the main SMPS is functioning correctly. If the main SMPS is disabled, the Power Good pin is immediately released and the DSP board is muted. A Power Good signal is available on HBUS1 and HBUS2. When no amplifier is connected to HBUS2, PwrGood2 will be ignored.

Parameter	Direction	Remarks	Min	Typ	Max	Unit	Note
Power good	Input	Active LOW	0.00	-	0.66	V_{DC}	
Power not good			2.64	-	3.30	V_{DC}	

4.5 Amplifier Clip Indicator

If a clip condition occurs the Amplifier Clip Indicator pin will be pulled to ground. The red Protection LED will light up.

Parameter	Direction	Remarks	Min	Typ	Max	Unit	Note
Clipping	Input	Active LOW	0.0	-	0.8	V_{DC}	
Not clipping			2.0	-	3.3	V_{DC}	

5 Connector pinouts

This chapter describes the functional connectors of the DSP module and optional digital board. A connector not stated in this chapter is only used for production or quality control and must remain unconnected in the end user application. The arrows in figure 4 point towards pin 1 of the connector. For more information regarding a specific connector, please refer to the corresponding datasheet.

5.1 DSP3-224 with DIGin3-322 connectors and controls

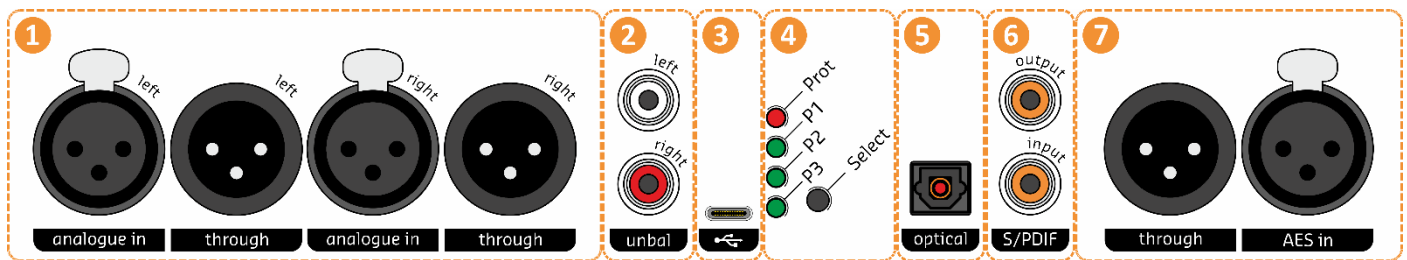

Figure 2: DSP with optional digital input board

DSP3-224 main board connectors

Number	Designator	Function	Pinout	Notes
1	J2	XLR analogue LEFT in	1: GND 2: Positive (hot) 3: Negative (cold)	
	J4	XLR analogue LEFT through	1: GND 2: Positive (hot) 3: Negative (cold)	J4 directly connected to J2
	J18	XLR analogue RIGHT in	1: GND 2: Positive (hot) 3: Negative (cold)	
	J19	XLR analogue RIGHT through	1: GND 2: Positive (hot) 3: Negative (cold)	J19 directly connected to J18
2	J5	RCA analogue in LEFT RCA analogue in RIGHT		
3	J11	USB-C		
4		LED indicators		
		Select button		Preset select/Digital channel select

DIGin3-322 input board connectors

5	J5	Toslink in		
6	J4	S/PDIF in		
		S/PDIF out		
7	J1	AES/EBU in	1: GND	
			2: Positive (hot)	
			3: Negative (cold)	
7	J2	AES/EBU through	1: GND	
			2: Positive (hot)	
			3: Negative (cold)	

LED Indicators and button

Clip or Limit indication:

Red "Prot" led:

- Random blinking: Amplifier limits (or soft clip limiter active)
- Steady on: Fatal / DC Error / Power failure
- Blink once per second: High temperature (volume is reduced by 6dB)
- Blink twice per second: Over temperature

Preset:

- P1: Preset 1 selected
- P2: Preset 2 selected
- P3: Preset 3 selected

When the DSP module is muted, the current preset LED (P1, P2 or P3) will blink slowly.

Preset selection

The selected preset LED is lit by default. To change the preset, short press the select button, use HFD or use the remote control (optional IR kit).

Button

- Select preset or hold for 2 seconds to switch module on.
- Bootloader force: Power off module, press and hold button, power on module and hold button pressed until all preset LEDs are lit.

Note: In case Hypex NC-MP/NCAS modules are used for powering the DSP, after removal of the mains voltage, the 5V standby supply will keep running until the buffer-capacitors are fully discharged, but the DSP will immediately fall into power-fail mode. Discharging the buffers can take up to two minutes, during which the red led will be lit and the DSP will try to reboot about every 5 seconds (green led will also be lit for a short duration, while booting the DSP).

5.2 DSP3-224 board IO pins

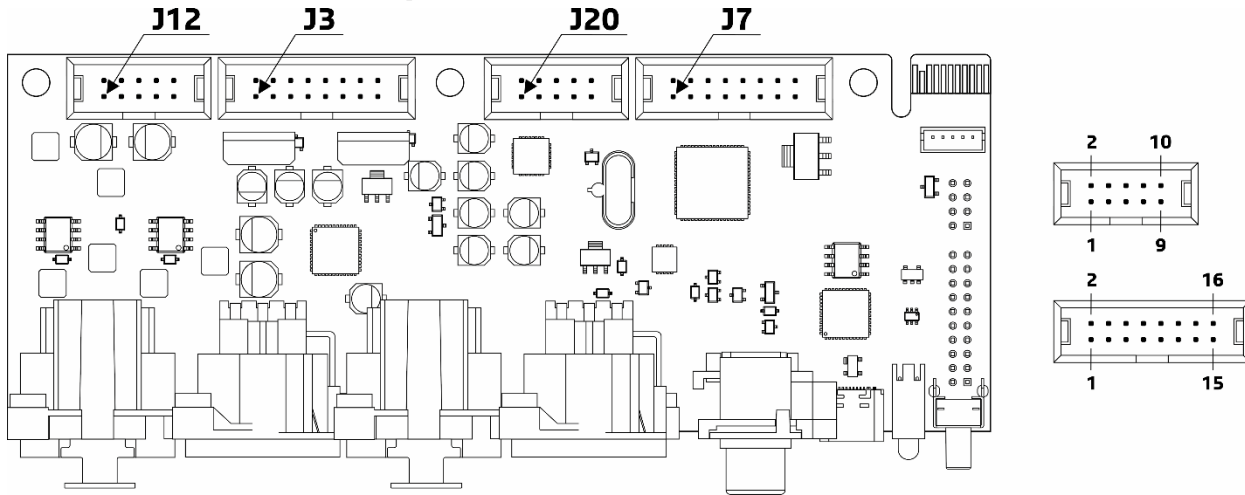

Figure 3: DSP board IO pins, top view (arrow pointing at pin 1)

H-box 1 connector J3

Pin	Direction	Function	Remarks
J3.1	Output	CH1 Out -	Inverting audio output Channel 1
J3.2	Output	CH1 Out +	Non-inverting audio output Channel 1
J3.3	-	CH1 GND	Ground
J3.4	Output	Mute	Amplifier mute (both channels)
J3.5	Input	CH1 Clip	Clip indicator Channel 1
J3.6	Output	CH1 HWAddr	Not connected
J3.7	Input	CH1 ISense(1)	Not connected
J3.8	Input	CH1 Thermal	Temperature readout Channel 1
J3.9	Input	CH2 Thermal	Temperature readout Channel 2
J3.10	Input	CH2 ISense(2)	Not connected
J3.11	Output	CH2 HWAddr	Not connected
J3.12	Input	CH2 Clip	Clip indicator Channel 2
J3.13	Output	Mute	Amplifier mute (both channels)
J3.14	-	CH2 GND	Ground
J3.15	Output	CH2 Out +	Non-inverting audio output Channel 2
J3.16	Output	CH2 Out -	Inverting audio output Channel 2

Connector type equivalent: T821116A1S100CEU Contact material: Brass, gold flash over nickel

H-bus 1 connector J12

Pin	Direction	Function	Remarks
J12.1	Input	V _{AUX}	Positive auxiliary supply
J12.2	Input	V _{AUX}	Negative auxiliary supply
J12.3	Input	V _{IN,STANDBY}	Regulated standby supply
J12.4	-	GND	Ground
J12.5	-	SDA (I ² C)	Not implemented
J12.6	-	SCL (I ² C)	Not implemented
J12.7	Input	DC Error	DC Offset detected, power supply disabled.
J12.8	Input	Power Good	Power supply stable indicator
J12.9	Output	PS Enable	Power supply enable
J12.10	Reserved	Reserved	Not connected

Connector type equivalent: T821110A1S100CEU Contact material: Brass, gold flash over nickel

H-box 2 connector J7

Pin	Direction	Function	Remarks
J7.1	Output	CH3 Out -	Inverting audio output Channel 3
J7.2	Output	CH3 Out +	Non-inverting audio output Channel 3
J7.3	-	CH3 GND	Ground
J7.4	Output	Mute	Amplifier mute (both channels)
J7.5	Input	CH3 Clip	Clip indicator Channel 3
J7.6	Output	CH3 HWAddr	Not connected
J7.7	Input	CH3 ISense(3)	Not connected
J7.8	Input	CH3 Thermal	Temperature readout Channel 3
J7.9	Input	CH4 Thermal	Temperature readout Channel 4
J7.10	Input	CH4 ISense(4)	Not connected
J7.11	Output	CH4 HWAddr	Not connected
J7.12	Input	CH4 Clip	Clip indicator Channel 4
J7.13	Output	Mute	Amplifier mute (both channels)
J7.14	-	CH4 GND	Ground
J7.15	Output	CH4 Out +	Non-inverting audio output Channel 4
J7.16	Output	CH4 Out -	Inverting audio output Channel 4

Connector type equivalent: T821116A1S100CEU Contact material: Brass, gold flash over nickel

H-bus 2 connector J20

Pin	Direction	Function	Remarks
J20.1	Input	V _{AUX}	Not used on DSP3-224
J20.2	Input	V _{AUX}	Not used on DSP3-224
J20.3	Input	V _{IN,STANDBY}	Not used on DSP3-224
J20.4	-	GND	Ground
J20.5	-	SDA (I ² C)	Not implemented
J20.6	-	SCL (I ² C)	Not implemented
J20.7	Input	DC Error	DC Offset detected, power supply disabled.
J20.8	Input	Power Good	Power supply stable indicator
J20.9	Output	PS Enable	Power supply enable
J20.10	Reserved	Reserved	Not connected

Connector type equivalent: T821110A1S100CEU Contact material: Brass, gold flash over nickel

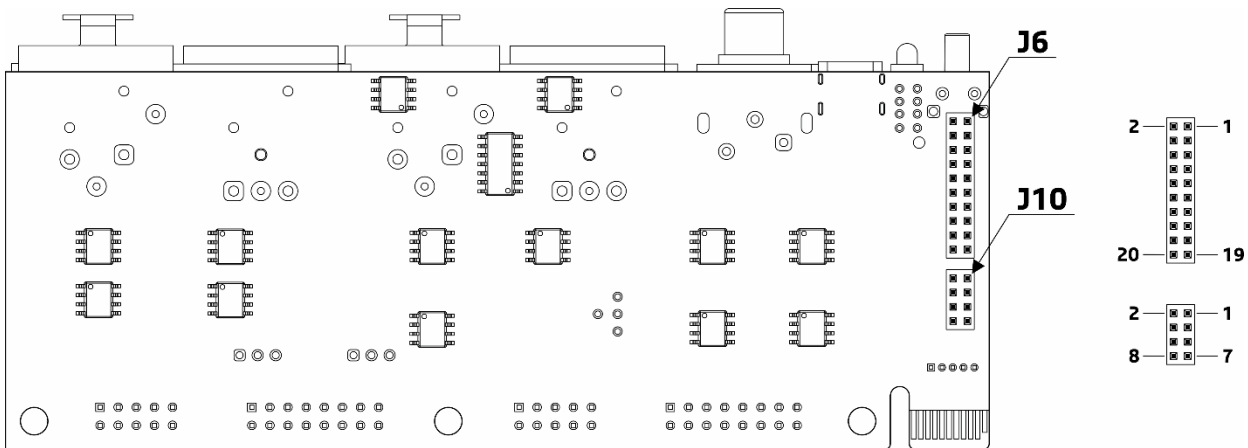

Figure 4: DSP board IO pins, bottom view (arrow pointing at pin 1)

Expansion 1 connector J6

This header is only to be used with the optional DIGin3-322 boards.

Pin	Direction	Function	Remarks
J6:1	Output	VENT_DAC	Fan control voltage 0-3V
J6:2	-	GND	Ground
J6:3	I/O	Option	Future use
J6:4	Input	SDIN4	I ² S data future use
J6:5	-	GND	Ground
J6:6	I/O	SPDIF_DATA	Communication over SPDIF data
J6:7	I/O	SRC_RESET	DIGin3-322 reset signal
J6:8	I/O	SDA	I ² C data
J6:9	Output	SCL	I ² C clock
J6:10	Output	SRC_MCLK	I ² S master clock
J6:11	Output	SRC_DATA	I ² S data
J6:12	Output	SDOUT3	I ² S auxiliary data
J6:13	Output	LRCK	I ² S LR clock
J6:14	Output	BCK	I ² S bit clock
J6:15	-	GND	Ground
J6:16	Output	+VAUX	Positive auxiliary supply voltage (switched) ¹⁾
J6:17	Output	+5VSB	Positive 5V digital supply voltage (always available) ²⁾
J6:18	Output	+3V3SB	Positive 3V3 digital supply voltage (always available) ²⁾
J6:19	Output	+12V	Positive analogue supply voltage (switched) ³⁾
J6:20	Output	-12V	Negative analogue supply voltage (switched) ³⁾

Note 1 +VAUX voltage level dependent on type NCxxxMP module, typical 20V, 300mA max. (FAN power rail)

Note 2 Max. 250mA (current drawn is added to the standby current draw)

Note 3 Max. 20mA

Expansion 2 connector J10

This header is only to be used with the optional DIGin3-322 boards.

Pin	Direction	Function	Remarks
J10:1	Input	SERIAL_IN	Serial data input (future use)
J10:2	Output	SERIAL_OUT	Serial data output (future use)
J10:3	-	+3V3SB	Positive 3V3 digital supply voltage. Max. 250mA ¹⁾
J10:4	-	GND	Ground
J10:5	-	+5VSB	Positive 5V digital supply voltage. Max 250mA ¹⁾
J10:6	-	GND	Ground
J10:7	Input	AUX_SPDIF_IN	Auxiliary DSP S/PDIF input (future use)
J10:8	Output	AUX_SPDIF_OUT	Auxiliary DSP S/PDIF output (future use)

Note 1 +3V3SB and +5VSB may both source 250mA, but keep in mind that the extra current drawn is added to the standby current draw.

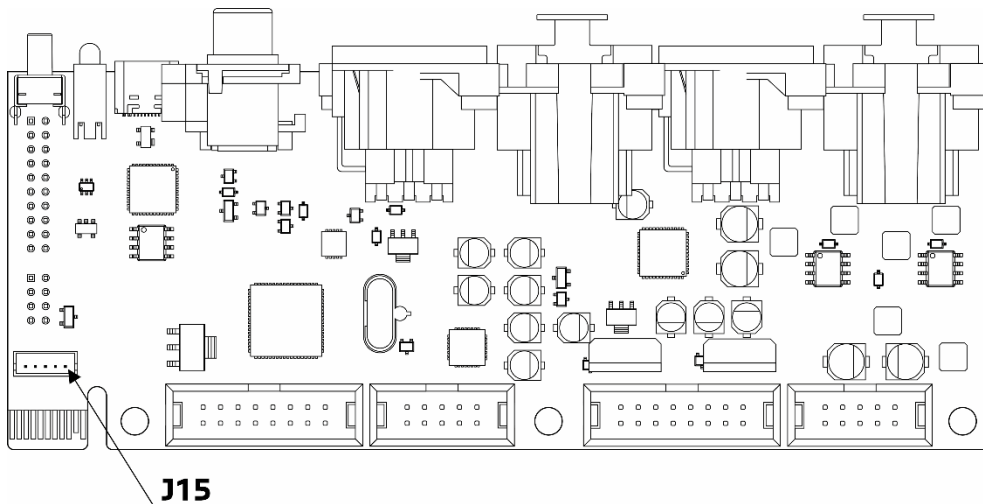

Figure 5: DSP main board IO pins, top view (arrow pointing at pin 1)

IR kit connector J15

Pin	Direction	Function	Remarks
J15:1	Output	+3V3	
J15:2	Input	IR input	
J15:3	-	GND	
J15:4	Output	Front LED1	DSP on (blinks when muted)
J15:5	Output	Front LED2	Clip/error detected

Connector type: JST B5B-ZR

5.3 DIGin3-322 IO pins

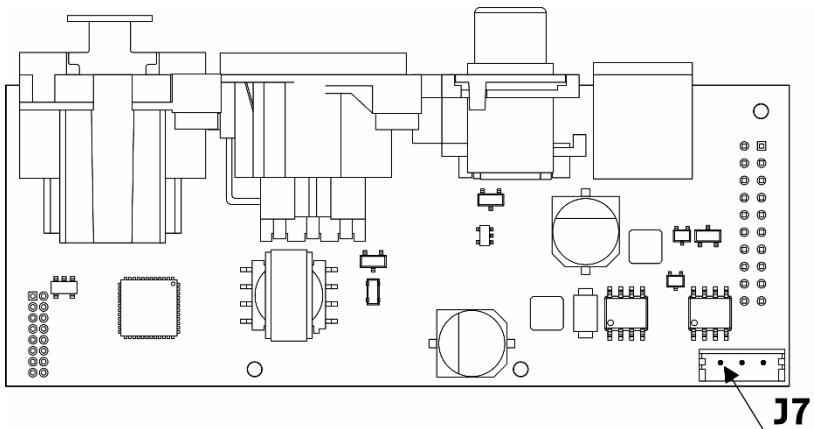

Figure 6: Dig-in IO pins, top view (arrow pointing at pin 1)

Fan connector J7

Pin	Direction	Function	Remarks
J7:1	Output	+12V	4-14V controlled by DSP-main
J7:2	-	GND	
J7:3	-	NC	Not connected

Connector type: JST B3B-EH-A

Compatible fan: JAMICON JF0925B1HS-R

6 Features

Gain setting

The gain can be increased for the XLR (two jumpers, left and right) and RCA (four jumpers, two for left and two for right) inputs individually by soldering the corresponding jumpers. The jumpers are located on the bottom side of the DSP board. ALWAYS treat all corresponding jumpers the same.

Input	Jumpers	Input level	
		dBu	V _{RMS}
XLR	Both not set (default)	18	6.15
	Both set	9	2.18
RCA	None set (default)	9	2.18
	All set	2	0.98

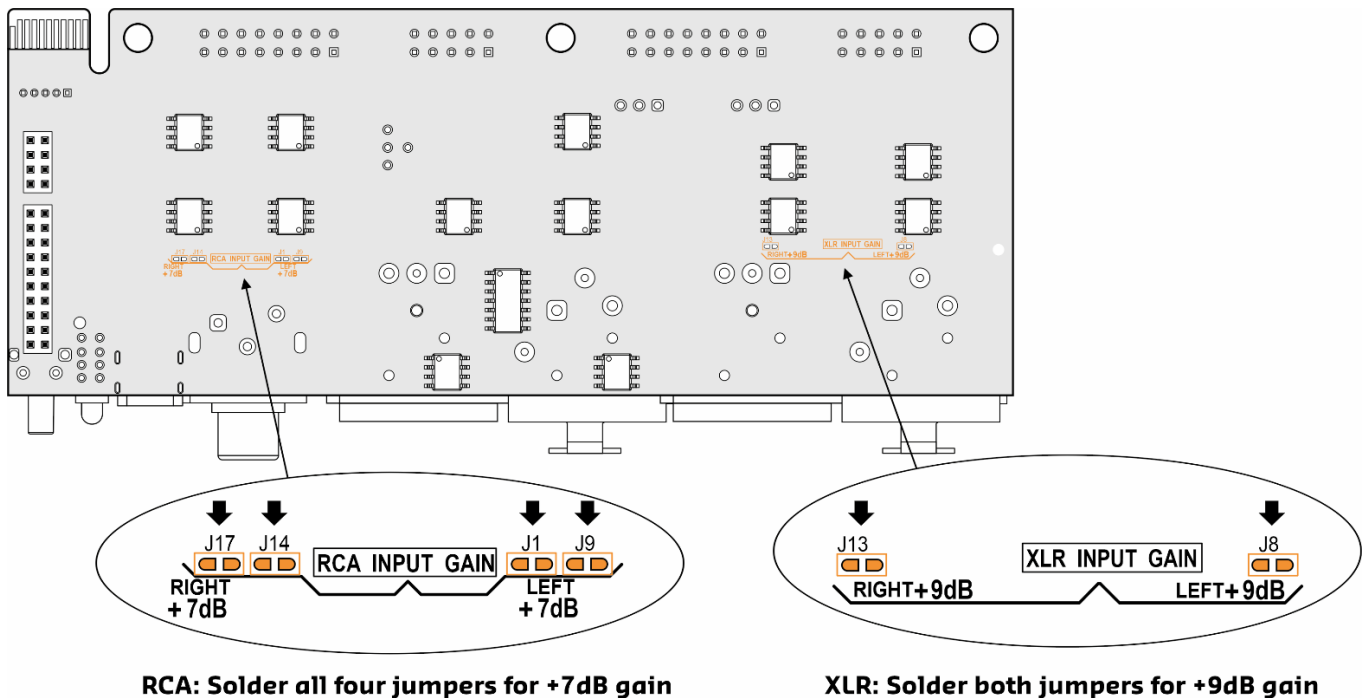

Figure 7: Gain jumper location

DSP Filters

- 15 biquads per channel. Channels configured for BTL still have 15 biquads available.
- One FIR filter with fixed 2048 taps on the input, or four 1024 tap FIR filters, one for each channel

Chip specification

DSP: ADAU1452
 ADC: AK5554
 DAC: AK4454
 SRC: SRC4382

Bridge-tied load (BTL)

Channels 1 and 2 or 3 and 4 can be configured for BTL operation by setting the BTL option in Hypex Filter design. Channel 2 will output the inverted signal of Channel 1, Channel 4 will output the inverted signal of channel 3. Please refer to the NCxxxMP data sheet for information on speaker wiring.

Fan output

The optional DIGin3-322 board features a fan output to connect an optional cooling fan . The software monitors the output signal and NCxxxMP module temperature. A proportional-integral algorithm controls the fan speed. This ensures sufficient cooling when needed and quiet operation when desired. The FAN is driven with a variable DC voltage, not pulse width modulated.

Source select

Automatic source select automatically locks on to the first available source. The input scanner scans in the following order and cycles:

- DSP board only configuration:
XLR | RCA
- DSP board fitted with Dig-in board:
AES | S/PDIF | Optical | XLR | RCA

During the scan cycle the output will be muted (Preset LED blinking). When no signal is detected on the active input for 15 seconds the cycle will start over. The source can also be selected manually. Configure manual or automatic source selection in HFD.

Daisy-chaining

The balanced analogue inputs can be daisy-chained using the XLR through connectors. This output XLR is directly connected to the input XLR. The maximum number of chained modules is limited by the source's capabilities.

When equipped with the DIGin3-322 board, multiple DSP3-224 boards can also be daisy chained in the digital domain. The signal on the AES and S/PDIF output is the signal of the current selected digital input.

Note: there is no link between analogue input and digital output domains. Analogue input signal cannot be routed to digital output.

Master-slave operation

When equipped with a DIGin3-322 expansion board, multiple DSP3-224 boards can be controlled by a single master DSP3-224 board by connecting an SPDIF cable from the SPDIF out or Remote out on the first module to the SPDIF in or Remote in on the second module, and so forth. In addition to the control signal, the SPDIF output on the Dig-in board also forwards the active digital input signal. Master unit should be the last with mains switched on (or at the same time as the last slave is connected to mains power).

NOTE: Due to various S/PDIF cable and connector quality differences, it is advised to keep S/PDIF sample rates under 100kHz, as control communication can interfere with sound quality at very high sample rates.

Hypex Filter Design (HFD)

HFD is a free software tool required to configure the DSP3-224. The DSP does not contain any filter by default. At least a unity filter needs to be configured and uploaded before the DSP will produce an output signal.

HFD can be used to design your filter. 15 biquad filters are available per amplifier channel. Also, one FIR filter is available (2048 taps) or a FIR filter per channel (each 1024 taps). It is advisable to setup and enable the softclip limiter when designing and uploading filters. This can protect your drivers in case the designed filter produces too much output (for example, when too much gain is implemented).

Please refer to the HFD help file for more information on using HFD. The most recent version of HFD is available for download on our website.

7 DSP flow diagrams

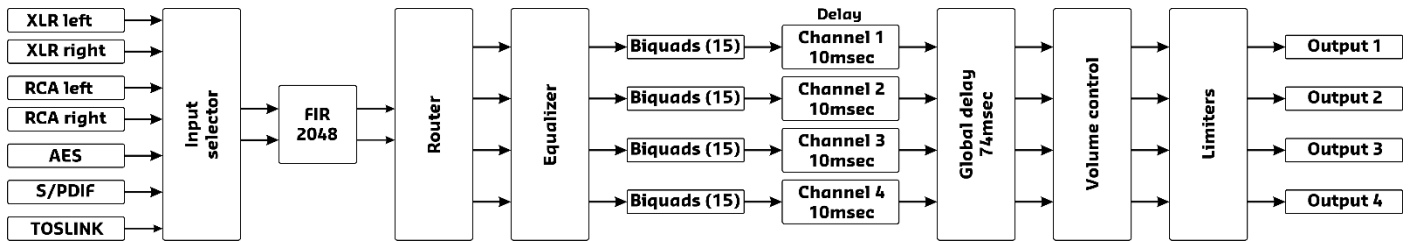

Figure 8: Input FIR configuration

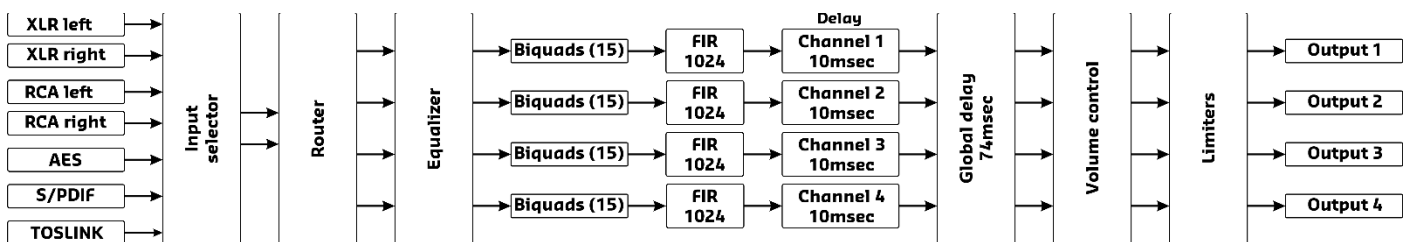

Figure 9: Output FIR configuration

Note 1: The FIR filter at the input as shown in figure 8 has a capacity of 2048 taps. The filter coefficients are the same for the left and right channel. When using the FIR filters in each output channel, these filters have 1024 taps and can use unique coefficients for each channel.

Note 2: Each channel has a delay of 0..10msec which can be used to solve driver distances within the same speaker cabinet. The global delay of 0..74msec can be used to position the speaker cabinet. These delays are configurable in the Hypex Filter Design application, which can be downloaded from the Hypex website.

8 Dimensions

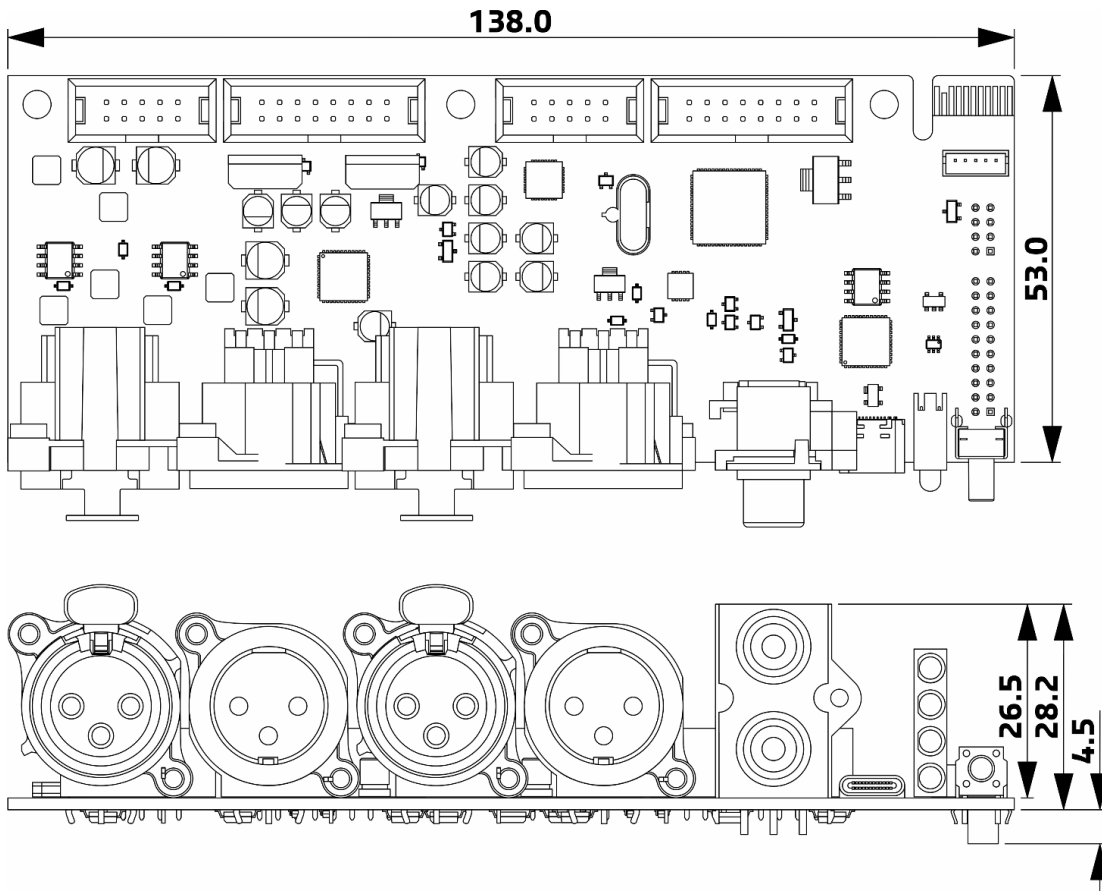

Figure 10: DSP3-224 dimensions (mm)

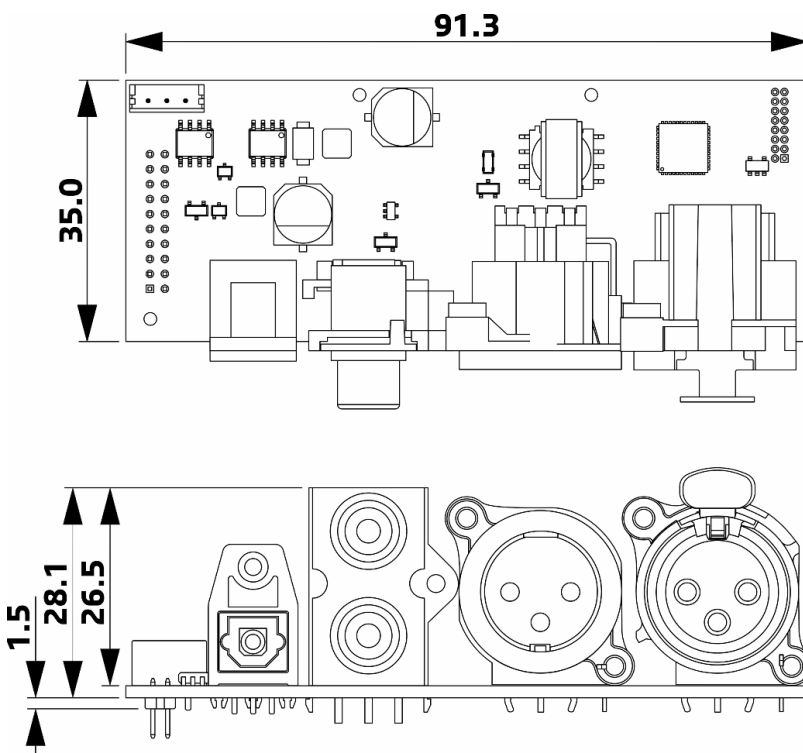

Figure 11: Digin3-322 dimensions (mm)

9 Revisions

Document revision	Module revision	Change log	Date
R1	0101	First release 0101	November '24
R2	0102	Minor PCB updates	April '25

10 Disclaimer

All products, product specifications and data are subject to change without notice to improve reliability, function or design or otherwise.

Hypex Electronics BV, its affiliates, agents, and employees, and all persons acting on its or their behalf (collectively, "Hypex Electronics"), disclaim any and all liability for any errors, inaccuracies or incompleteness contained in any datasheet or in any other disclosure relating to any product.

This subassembly is designed for use in music reproduction equipment only. No representations are made as to fitness for other uses. Except where noted otherwise, any specifications given pertain to this subassembly only. Responsibility for verifying the performance, safety, reliability and compliance with legal standards of end products using this subassembly falls to the manufacturer of said end product.

LIFE SUPPORT POLICY: Use of Hypex products in life support equipment or equipment whose failure can reasonably be expected to result in injury or death is not permitted except by explicit written consent from Hypex Electronics BV.